

POWER

Power is the description for electrical feedthroughs used for the transmission of high voltages and/or high current into vacuum systems. Power feedthrough options include many variations of design which offer a broad range of voltage and current. High purity alumina ceramic insulators provide electrical isolation and various conductor materials offer specific current capacities.

MPF offers several mounting options for power feedthroughs: Weldable, Quick Flange (QF), Conflat Flange (CF), and Baseplate (BP). Baseplate versions of power feedthroughs are commonly used in vacuum furnaces and vacuum coating applications. Many designs are also configured for NPT style adapters. Custom adapters, plates and flange configurations are available by request.

High Voltage and High Current

The voltage rating for feedthroughs is determined by the length of the ceramic insulator, or the surface distance in the case of fluted designs. MPF offers power feedthroughs with voltage ratings up to 60,000 Volts DC.

The current rating for feedthroughs is dependent on the conductor material. The choice of which must consider other factors such as strength and corrosion resistance. Copper gives the best current capacity, while stainless steel offers high strength and resistance to corrosion. Nickel, Alumel and Molybdenum are other popular conductor materials. MPF offers power feedthroughs with current ratings to 1000 Amps.



Water-cooled and RF Power

Water-cooled feedthroughs are intended for use with grounded, closed-loop cooling systems and non-conductive coolants such as deionized water. Standard conductor options for these feedthroughs include copper, nickel and stainless tubes. Water-cooled feedthroughs are rated for up to 8000 Volts DC and up to 1000 Amps.

RF Power Feedthroughs are specifically designed for the transmission of Radio Frequency power into the vacuum environment. Non-magnetic materials are used in RF feedthroughs to reduce current induction. RF Feedthroughs are rated up to 3000 Volts DC and up to 1000 Amps.



Power Glove Connectors

MPF offers the Power Glove series of high voltage feedthroughs which includes an air-side connector / cable (96 inches) for safe and convenient termination of high voltage and high current leads.

Power Glove fitted feedthroughs are rated up to 20,000 Volts DC and up to 30 Amps.



Power

Section 4: Contents

Section	Type	Electrical Rating	Thermal Rating	Pages
4.1	Low Power 1, 2, 4 and 8 pins	Voltage: 500 to 1000 Volts DC Current: to 25 Amps per pin	Feedthrough: -100 to 450°C	78-82
4.2	Medium Power 4, 6 and 10 pins	Voltage: 2000 Volts DC Current: 10 Amps per pin	Feedthrough: -100 to 450°C	83-84
4.3	Medium Power Baseplate 1, 2, 3 and 4 pins	Voltage: 2000 Volts DC Current: 50 Amps per pin	Feedthrough: -20 to 150°C	85
4.4	High Power 1, 2, 3, 4, 8 and 12 pins	Voltage: 5000 to 8000 Volts DC Current: to 800 Amps per pin	Feedthrough: -100 to 450°C	86-95
4.5	High Power Baseplate 1 pin	Voltage: 3000 to 12,000 Volts DC Current: to 250 Amps per pin	Feedthrough: -20 to 150°C	96-97
4.6	High Voltage 1, 2, 3 and 4 pins	Voltage: 10,000 to 60,000 Volts DC Current: to 180 Amps per pin	Feedthrough: -100 to 450°C	98-109
4.7	Water-Cooled 1, 2, 3 and 4 pins	Voltage: to 8000 Volts DC Current: to 1000 Amps per pin	Feedthrough: -100 to 450°C	110-114
4.8	RF Power 1 and 2 pins	Voltage: to 8000 Volts DC Power: to 10 KW at 450 KHz	Feedthrough: -100 to 450°C	115-116
4.9	Power Glove 1, 2 and 4 pins	Voltage: 5000 to 20,000 Volts DC Current: to 30 Amps per pin	Feedthrough: -100 to 450°C Air-side Connector: -55 to 125°C	117-119

Operating Conditions

The electrical and thermal ratings specified are safe operating limits determined by various factors including material properties, mechanical design, and the intended operating environment. All electrical ratings are based on operation with one side in dry atmosphere and the other side in vacuum of 1×10^{-4} Torr maximum pressure. Temperature ratings for various mounting options may reduce the operating range of an assembly. All assemblies have a maximum thermal gradient of 25°C per minute and may be damaged if this limit is exceeded.

500 & 1000 Volts DC / to 25 Amps / 1 to 8 Pins WELDABLE

Fig. 1

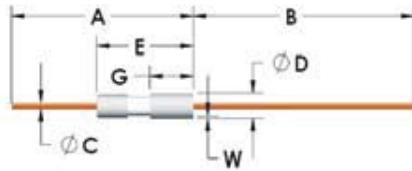
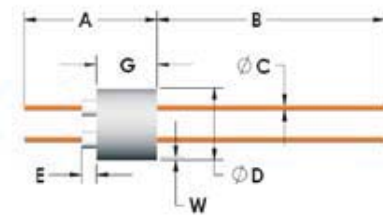

Fig. 2



VOLTS	PINS	AMPS	CONDUCTOR	FIG	A	B	C	D	E	G	W	PART #	PRICE
500	1	8	MOLY	1	1.10	1.00	.032	.154	.60	.27	.015	A0495-1-W	30.00
500	1	15	COPPER	1	1.10	1.00	.032	.154	.60	.27	.015	A0495-2-W	30.00
500	1	5	NICKEL	1	1.10	1.00	.032	.154	.60	.27	.015	A0495-3-W	30.00
500	1	1	STN STL	1	1.10	1.00	.032	.154	.60	.27	.015	A0495-4-W	30.00
500	1	15	COPPER	1	1.10	1.00	.032	.154	.60	.27	.015	A0070-2-W *	30.00
500	1	2	CONSTANTAN	1	1.10	1.00	.032	.154	.60	.27	.015	A0070-1-W *	30.00
500	1	1	STN STL	1	1.10	1.00	.032	.154	.60	.27	.015	A0070-3-W *	30.00
500	2	8	MOLY	2	1.00	1.50	.032	.497	.53	.43	.020	A0078-4-W	60.00
500	2	15	COPPER	2	1.00	1.50	.032	.497	.53	.43	.020	A0078-3-W	60.00
500	2	5	NICKEL	2	1.00	1.50	.032	.497	.53	.43	.020	A0078-1-W	60.00
500	2	1	STN STL	2	1.00	1.50	.032	.497	.53	.43	.020	A0078-2-W	60.00
500	4	8	MOLY	2	1.00	1.50	.032	.497	.53	.43	.020	A0086-4-W	70.00
500	4	15	COPPER	2	1.00	1.50	.032	.497	.53	.43	.020	A0086-3-W	70.00
500	4	5	NICKEL	2	1.00	1.50	.032	.497	.53	.43	.020	A0086-1-W	70.00
500	4	1	STN STL	2	1.00	1.50	.032	.497	.53	.43	.020	A0086-2-W	70.00
500	8	8	MOLY	2	1.00	1.50	.032	.747	.63	.53	.030	A0089-4-W	100.00
500	8	15	COPPER	2	1.00	1.50	.032	.747	.63	.53	.030	A0089-3-W	100.00
500	8	5	NICKEL	2	1.00	1.50	.032	.747	.63	.53	.030	A0089-1-W	100.00
500	8	1	STN STL	2	1.00	1.50	.032	.747	.63	.53	.030	A0089-2-W	100.00
1000	1	25	COPPER	1	1.75	2.25	.050	.247	.75	.37	.015	A0076-3-W	30.00
1000	1	8	NICKEL	1	1.75	2.25	.050	.247	.75	.37	.015	A0076-2-W	30.00
1000	1	1	STN STL	1	1.75	2.25	.050	.247	.75	.37	.015	A0076-1-W	30.00
1000	2	25	COPPER	2	1.75	1.87	.050	.747	.67	.53	.030	A0087-3-W	50.00
1000	2	8	NICKEL	2	1.75	1.87	.050	.747	.67	.53	.030	A0087-1-W	50.00
1000	2	1	STN STL	2	1.75	1.87	.050	.747	.67	.53	.030	A0087-2-W	50.00
1000	4	25	COPPER	2	1.75	1.87	.050	.747	.67	.53	.030	A0088-3-W	75.00
1000	4	8	NICKEL	2	1.75	1.87	.050	.747	.67	.53	.030	A0088-1-W	75.00
1000	4	1	STN STL	2	1.75	1.87	.050	.747	.67	.53	.030	A0088-2-W	75.00
1000	8	25	COPPER	2	1.25	2.75	.050	.747	.67	.53	.030	A0860-3-W	100.00
1000	8	8	KOVAR	2	1.25	2.75	.050	.747	.67	.53	.030	A0860-1-W	100.00
1000	8	13	MOLY	2	1.25	2.75	.050	.747	.67	.53	.030	A0860-2-W	100.00

*Indicates suitable for liquid helium applications (not weldable).

500 & 1000 Volts DC / to 25 Amps / 2 to 8 Pins
CONFLAT FLANGE

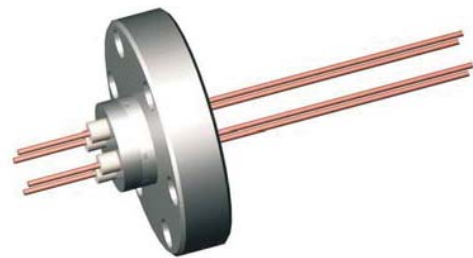
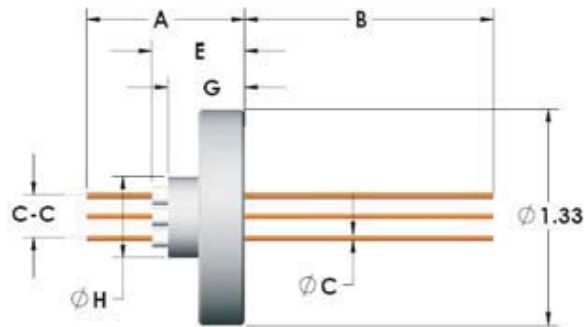

VOLTS	PINS	AMPS	CONDUCTOR	FLANGE	A	B	C	E	G	H	C-C	PART #	PRICE
500	2	8	MOLY	CF16	.99	1.52	.032	.58	.48	.50	.21	A0496-4-CF	110.00
500	2	15	COPPER	CF16	.99	1.52	.032	.58	.48	.50	.21	A0496-3-CF	110.00
500	2	5	NICKEL	CF16	.99	1.52	.032	.58	.48	.50	.21	A0496-1-CF	110.00
500	2	1	STN STL	CF16	.99	1.52	.032	.58	.48	.50	.21	A0496-2-CF	110.00
500	4	8	MOLY	CF16	.99	1.52	.032	.58	.48	.50	.25	A0497-4-CF	120.00
500	4	15	COPPER	CF16	.99	1.52	.032	.58	.48	.50	.25	A0497-3-CF	120.00
500	4	5	NICKEL	CF16	.99	1.52	.032	.58	.48	.50	.25	A0497-1-CF	120.00
500	4	1	STN STL	CF16	.99	1.52	.032	.58	.48	.50	.25	A0497-2-CF	120.00
500	8	15	COPPER	CF16	1.53	.97	.032	1.13	1.03	.75	.43	A0266-3-CF	145.00
500	8	8	MOLY	CF16	1.53	.97	.032	1.13	1.03	.75	.43	A0266-4-CF	145.00
500	8	5	NICKEL	CF16	1.53	.97	.032	1.13	1.03	.75	.43	A0266-1-CF	145.00
500	8	1	STN STL	CF16	1.53	.97	.032	1.13	1.03	.75	.43	A0266-2-CF	145.00
1000	2	25	COPPER	CF16	2.63	1.37	.050	1.17	1.03	.75	.31	A0261-3-CF	90.00
1000	2	8	NICKEL	CF16	2.63	1.37	.050	1.17	1.03	.75	.31	A0261-1-CF	90.00
1000	2	1	STN STL	CF16	2.63	1.37	.050	1.17	1.03	.75	.31	A0261-2-CF	90.00
1000	4	25	COPPER	CF16	2.63	1.37	.050	1.17	1.03	.75	.38	A0262-3-CF	105.00
1000	4	8	NICKEL	CF16	2.63	1.37	.050	1.17	1.03	.75	.38	A0262-1-CF	105.00
1000	4	1	STN STL	CF16	2.63	1.37	.050	1.17	1.03	.75	.38	A0262-2-CF	105.00
1000	8	25	COPPER	CF16	1.75	3.50	.050	1.25	1.25	.75	.43	A0863-3-CF	140.00
1000	8	8	KOVAR	CF16	1.75	3.50	.050	1.25	1.25	.75	.43	A0863-1-CF	140.00
1000	8	13	MOLY	CF16	1.75	3.50	.050	1.25	1.25	.75	.43	A0863-2-CF	140.00

See Section 7 for connectors, wiring, and other accessories.



500 Volts DC / to 15 Amps / 2 to 8 Pins
QUICK FLANGE

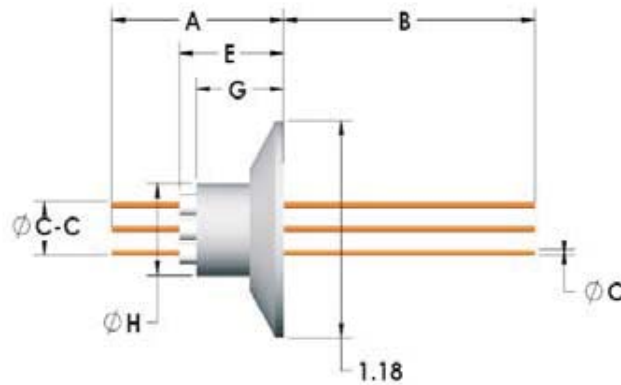

PINS	AMPS	CONDUCTOR	FLANGE	A	B	C	E	G	H	C-C	PART #	PRICE
2	8	MOLY	QF16	1.03	1.47	.032	.63	.53	.50	.21	A0500-4-QF	110.00
2	15	COPPER	QF16	1.03	1.47	.032	.63	.53	.50	.21	A0500-3-QF	110.00
2	5	NICKEL	QF16	1.03	1.47	.032	.63	.53	.50	.21	A0500-1-QF	110.00
2	1	STN STL	QF16	1.03	1.47	.032	.63	.53	.50	.21	A0500-2-QF	110.00
4	8	MOLY	QF16	1.03	1.47	.032	.63	.53	.50	.25	A0501-4-QF	120.00
4	15	COPPER	QF16	1.03	1.47	.032	.63	.53	.50	.25	A0501-3-QF	120.00
4	5	NICKEL	QF16	1.03	1.47	.032	.63	.53	.50	.25	A0501-1-QF	120.00
4	1	STN STL	QF16	1.03	1.47	.032	.63	.53	.50	.25	A0501-2-QF	120.00
8	15	COPPER	QF16	1.53	.97	.032	1.13	1.03	.75	.43	A0502-3-QF	145.00
8	8	MOLY	QF16	1.53	.97	.032	1.13	1.03	.75	.43	A0502-4-QF	145.00
8	5	NICKEL	QF16	1.53	.97	.032	1.13	1.03	.75	.43	A0502-1-QF	145.00
8	1	STN STL	QF16	1.53	.97	.032	1.13	1.03	.75	.43	A0502-2-QF	145.00



1000 Volts DC / to 25 Amps / 2 to 8 Pins
QUICK FLANGE

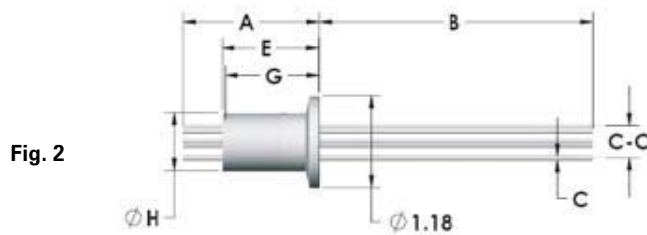
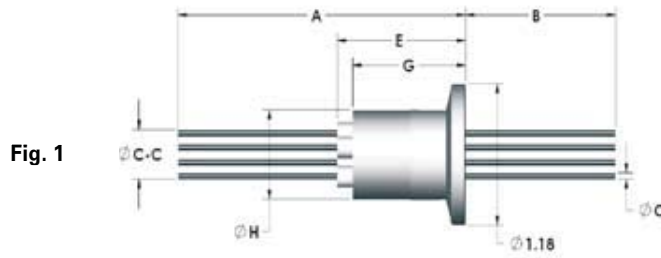

PINS	AMPS	CONDUCTOR	FIG	FLANGE	A	B	C	E	G	H	C-C	PART #	PRICE
2	25	COPPER	1	QF16	2.63	1.37	.05	1.17	1.03	.75	.31	A0498-3-QF	90.00
2	8	NICKEL	1	QF16	2.63	1.37	.05	1.17	1.03	.75	.31	A0498-1-QF	90.00
2	1	STN STL	1	QF16	2.63	1.37	.05	1.17	1.03	.75	.31	A0498-2-QF	90.00
4	25	COPPER	1	QF16	2.63	1.37	.05	1.17	1.03	.75	.38	A0499-3-QF	105.00
4	8	NICKEL	1	QF16	2.63	1.37	.05	1.17	1.03	.75	.38	A0499-1-QF	105.00
4	1	STN STL	1	QF16	2.63	1.37	.05	1.17	1.03	.75	.38	A0499-2-QF	105.00
8	7	KOVAR	2	QF16	1.75	3.50	.05	1.25	1.25	.75	.43	A2572-1-QF	135.00
8	25	COPPER	2	QF16	1.75	3.50	.05	1.25	1.25	.75	.43	A2572-3-QF	135.00
8	13	MOLY	2	QF16	1.75	3.50	.05	1.25	1.25	.75	.43	A2572-2-QF	135.00



1000 Volts DC / to 25 Amps / 2 to 8 Pins
1" BASEPLATE

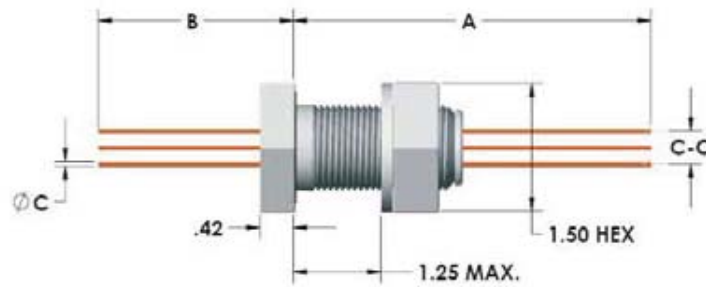

PINS	AMPS	CONDUCTOR	A	B	C	C-C	PART #	PRICE
2	25	COPPER	4.18	2.32	.05	.31	A0505-1-BP	170.00
2	8	NICKEL	4.18	2.32	.05	.31	A0505-2-BP	170.00
2	1	STN STL	4.18	2.32	.05	.31	A0505-3-BP	170.00
4	25	COPPER	4.18	2.32	.05	.38	A0504-1-BP	225.00
4	8	NICKEL	4.18	2.32	.05	.38	A0504-2-BP	225.00
4	1	STN STL	4.18	2.32	.05	.38	A0504-3-BP	225.00
8	7	KOVAR	3.83	1.92	.05	.43	A0971-1-BP	280.00
8	25	COPPER	3.83	1.92	.05	.43	A0971-2-BP	280.00

See Section 7 for connectors, wiring, and other accessories.



2000 Volts DC / 10 Amps / 4, 6, & 10 Pins
All Conductors Alumel
WELDABLE

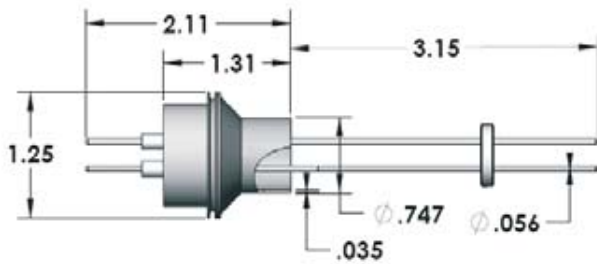

PINS	PART #	PRICE
4	A0421-4-W	130.00
6	A0422-4-W	150.00
10	A0184-4-W	190.00

CONFLAT FLANGE

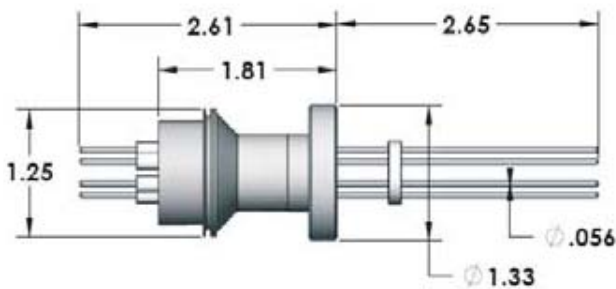

PINS	PART #	PRICE
4	A0423-4-CF	155.00
6	A0423-8-CF	175.00
10	A0423-12-CF	230.00

See Section 7 for connectors, wiring, and other accessories.



2000 Volts DC / 10 Amps / 4, 6, & 10 Pins
All Conductors Alumel
QUICK FLANGE

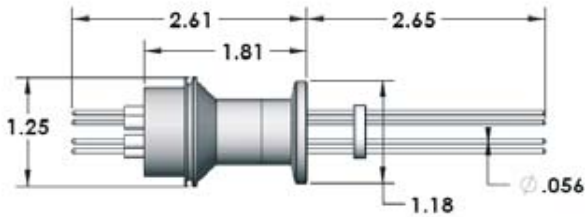

PINS	PART #	PRICE
4	A0425-4-CF	155.00
6	A0425-8-CF	175.00
10	A0425-12-CF	230.00

NPT PIPE THREAD

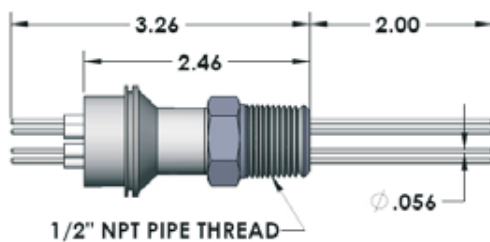

PINS	PART #	PRICE
4	A0424-4-NPT	190.00
6	A0424-8-NPT	205.00
10	A0424-12-NPT	250.00

See Section 7 for connectors, wiring, and other accessories.



2000 Volts DC / to 50 Amps / 1 to 4 Pins
1" BASEPLATE

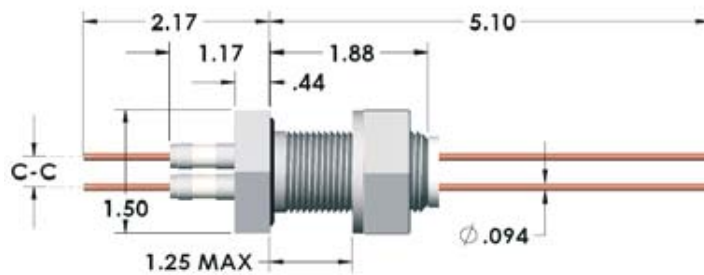

PINS	AMPS	CONDUCTOR	C-C	PART #	PRICE
1	50	COPPER	---	A0525-1-BP	140.00
1	15	NICKEL	---	A0525-2-BP	140.00
1	3	STN STL	---	A0525-3-BP	140.00
2	50	COPPER	.38	A0526-1-BP	200.00
2	15	NICKEL	.38	A0526-2-BP	200.00
2	3	STN STL	.38	A0526-3-BP	200.00
3	50	COPPER	.45	A0527-1-BP	225.00
3	15	NICKEL	.45	A0527-2-BP	225.00
3	3	STN STL	.45	A0527-3-BP	225.00
4	50	COPPER	.51	A0528-1-BP	280.00
4	15	NICKEL	.51	A0528-2-BP	280.00
4	3	STN STL	.51	A0528-3-BP	280.00

See Section 7 for connectors, wiring, and other accessories.



5000 Volts DC / to 180 Amps / 1 Pin WELDABLE

Fig. 1

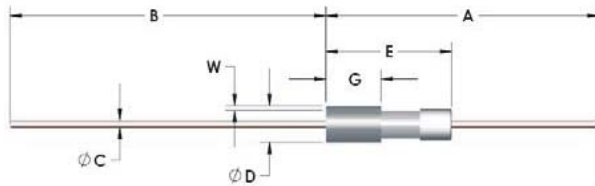
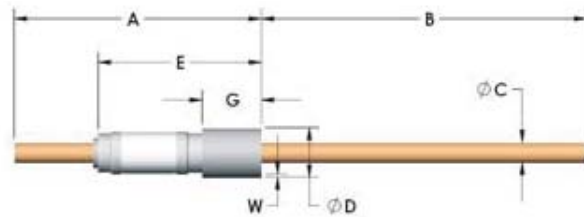

Fig. 2



AMPS	CONDUCTOR	FIG	A	B	C	D	E	G	W	PART #	PRICE
25	COPPER	1	1.85	2.15	.050	.247	.85	.37	.015	A0263-1-W	30.00
8	NICKEL	1	1.85	2.15	.050	.247	.85	.37	.015	A0263-2-W	30.00
1	STN STL	1	1.85	2.15	.050	.247	.85	.37	.015	A0263-3-W	30.00
50	COPPER	2	2.25	5.00	.094	.435	1.25	.50	.030	A0069-5-W	30.00
15	NICKEL	2	2.25	5.00	.092	.435	1.25	.50	.030	A0069-3-W	30.00
100	COPPER	2	2.32	4.93	.160	.495	1.32	.50	.030	A0284-1-W	42.00
30	NICKEL	2	2.32	4.93	.160	.495	1.32	.50	.030	A0284-2-W	42.00
180	COPPER	2	3.13	4.12	.250	.622	2.13	.75	.030	A0106-1-W	47.00
55	NICKEL	2	3.13	4.12	.250	.622	2.13	.75	.030	A0106-3-W	47.00
7	STN STL	2	3.13	4.12	.250	.622	2.13	.75	.030	A0106-2-W	47.00

See Section 7 for connectors, wiring, and other accessories.



5000 Volts DC / Ø Pins
WELDABLE

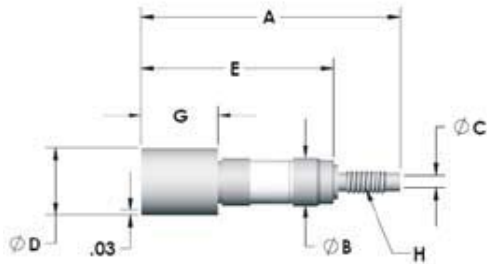

A	B	C	D	E	G	H	PART #	PRICE
1.69	0.31	.082	.435	1.26	0.50	8/32	A0036-1-W	40.00

5000 Volts DC / to 180 Amps / 1 Pin
NPT PIPE THREAD



AMPS	CONDUCTOR	NPT	HEX	A	B	C	E	G	H	PART #	PRICE
50	COPPER	.125	7/16	2.48	4.77	.094	1.48	.730	---	A0271-2-NPT	80.00
15	NICKEL	.125	7/16	2.48	4.77	.094	1.48	.730	---	A0271-1-NPT	80.00
25	COPPER	.125	7/16	2.48	4.77	.050	1.48	.730	---	A0271-4-NPT	80.00
8	NICKEL	.125	7/16	2.48	4.77	.050	1.48	.730	---	A0271-3-NPT	80.00
180	COPPER	.500	7/8	3.42	3.83	.250	2.42	1.09	.54	A0003-1-NPT	105.00
55	NICKEL	.500	7/8	3.42	3.83	.250	2.42	1.09	.54	A0003-5-NPT	105.00
7	STN STL	.500	7/8	3.42	3.83	.250	2.42	1.09	.54	A0003-3-NPT	105.00
100	COPPER	.375	11/16	2.71	4.54	.160	1.71	.890	.40	A0287-1-NPT	110.00
30	NICKEL	.375	11/16	2.71	4.54	.160	1.71	.890	.40	A0287-2-NPT	110.00

See Section 7 for connectors, wiring, and other accessories.



5000 Volts DC / to 25 Amps / 2 & 4 Pins WELDABLE

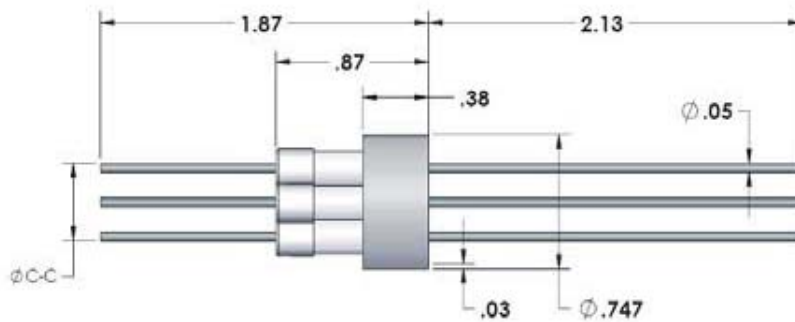

PINS	AMPS	CONDUCTOR	CC	PART #	PRICE
2	25	COPPER	.310	A0267-3-W	65.00
2	8	NICKEL	.310	A0267-1-W	65.00
2	1	STN STL	.310	A0267-2-W	65.00
4	25	COPPER	.375	A0268-3-W	75.00
4	8	NICKEL	.375	A0268-1-W	75.00
4	1	STN STL	.375	A0268-2-W	75.00

See Section 7 for connectors, wiring, and other accessories.



5000 Volts DC / to 25 Amps / 2 & 4 Pins
CONFLAT FLANGE

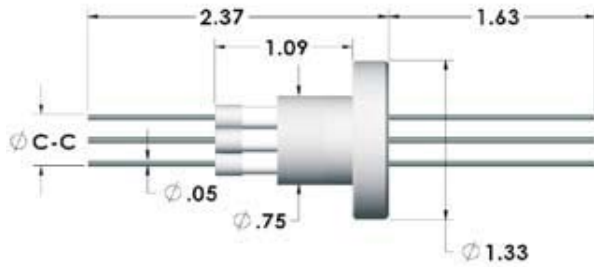

PINS	AMPS	CONDUCTOR	CC	PART #	PRICE
2	25	COPPER	.31	A0269-3-CF	105.00
2	8	NICKEL	.31	A0269-1-CF	105.00
2	1	STN STL	.31	A0269-2-CF	105.00
4	25	COPPER	.38	A0270-3-CF	115.00
4	8	NICKEL	.38	A0270-1-CF	115.00
4	1	STN STL	.38	A0270-2-CF	115.00

QUICK FLANGE

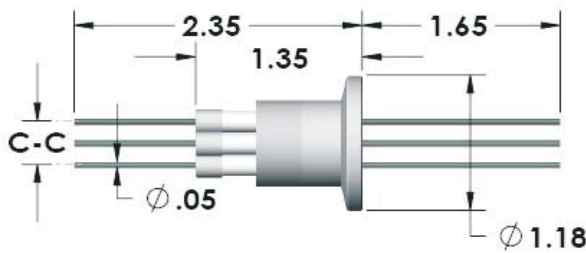

PINS	AMPS	CONDUCTOR	CC	PART #	PRICE
2	25	COPPER	.31	A0534-3-QF	105.00
2	8	NICKEL	.31	A0534-1-QF	105.00
2	1	STN STL	.31	A0534-2-QF	105.00
4	25	COPPER	.38	A0535-3-QF	115.00
4	8	NICKEL	.38	A0535-1-QF	115.00
4	1	STN STL	.38	A0535-2-QF	115.00

See Section 7 for connectors, wiring, and other accessories.



5000 Volts DC / to 50 Amps / 1 to 12 Pins CONFLAT FLANGE

Fig. 1

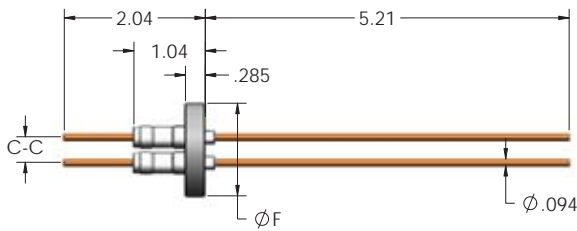
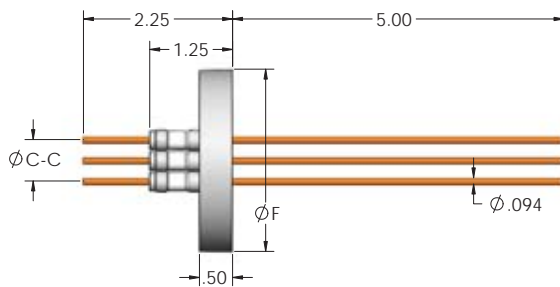

Fig. 2



PINS	AMPS	CONDUCTOR	FIG	FLANGE	F	CC	PART #	PRICE
1	50	COPPER	1	CF16	1.33	---	A0273-1-CF	75.00
1	15	NICKEL	1	CF16	1.33	---	A0273-2-CF	75.00
2	50	COPPER	1	CF16	1.33	.36	A0275-1-CF	135.00
2	15	NICKEL	1	CF16	1.33	.36	A0275-2-CF	135.00
2	50	COPPER	2	CF40	2.75	.50	A0279-2-CF	140.00
2	15	NICKEL	2	CF40	2.75	.50	A0279-1-CF	140.00
3	50	COPPER	1	CF16	1.33	.40	A0277-1-CF	160.00
3	15	NICKEL	1	CF16	1.33	.40	A0277-2-CF	160.00
4	50	COPPER	2	CF40	2.75	.62	A0280-2-CF	185.00
4	15	NICKEL	2	CF40	2.75	.62	A0280-1-CF	185.00
8	50	COPPER	2	CF40	2.75	1.00	A0281-2-CF	300.00
8	15	NICKEL	2	CF40	2.75	1.00	A0281-1-CF	300.00
12	50	COPPER	2	CF40	2.75	1.21	A0283-2-CF	365.00
12	15	NICKEL	2	CF40	2.75	1.21	A0283-1-CF	365.00

See Section 7 for connectors, wiring, and other accessories.



5000 Volts DC / to 50 Amps / 1 to 12 Pins
QUICK FLANGE

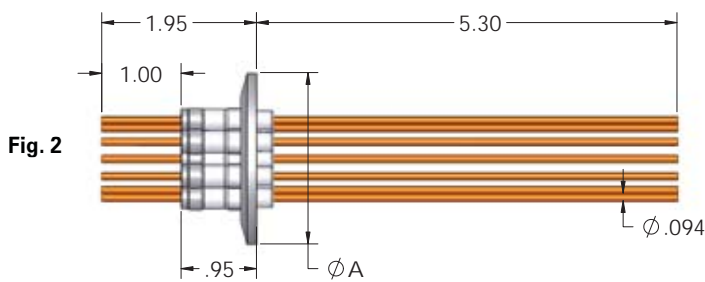
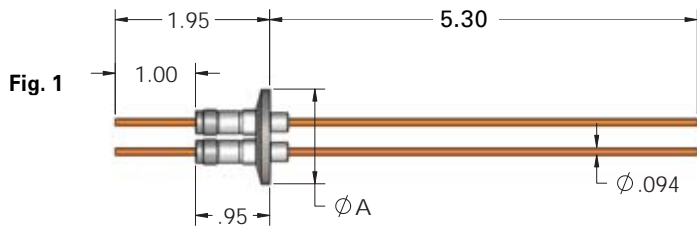

PINS	AMPS	CONDUCTOR	FIG	FLANGE	A	CC	PART #	PRICE
1	50	COPPER	1	QF16	1.18	---	A0516-2-QF	75.00
1	15	NICKEL	1	QF16	1.18	---	A0516-1-QF	75.00
2	50	COPPER	1	QF16	1.18	.39	A0818-2-QF	135.00
2	15	NICKEL	1	QF16	1.18	.39	A0818-1-QF	135.00
2	50	COPPER	2	QF40	2.16	.50	A0515-2-QF	140.00
2	15	NICKEL	2	QF40	2.16	.50	A0515-1-QF	140.00
3	50	COPPER	1	QF16	1.18	.40	A0514-2-QF	160.00
3	15	NICKEL	1	QF16	1.18	.40	A0514-1-QF	160.00
4	50	COPPER	2	QF40	2.16	.62	A0513-2-QF	185.00
4	15	NICKEL	2	QF40	2.16	.62	A0513-1-QF	185.00
8	50	COPPER	2	QF40	2.16	1.00	A0509-2-QF	300.00
8	15	NICKEL	2	QF40	2.16	1.00	A0509-1-QF	300.00
12	50	COPPER	2	QF40	2.16	1.25	A0820-2-QF	365.00
12	15	NICKEL	2	QF40	2.16	1.25	A0820-1-QF	365.00



5000 Volts DC / to 180 Amps / 1 to 4 Pins CONFLAT FLANGE

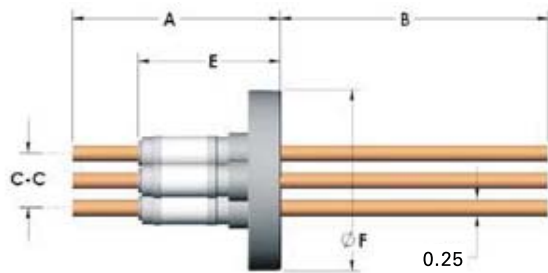
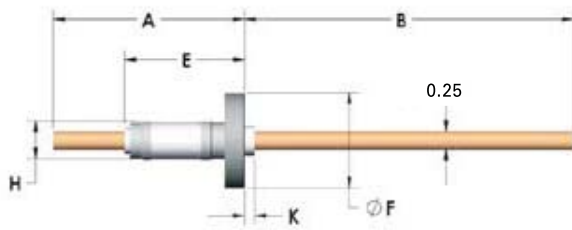

PINS	AMPS	CONDUCTOR	A	B	E	F	K	CC	PART #	PRICE
1	180	COPPER	2.67	4.58	1.67	1.33	0.14	---	A0049-1-CF	85.00
1	55	NICKEL	2.67	4.58	1.67	1.33	0.14	---	A0049-5-CF	85.00
1	7	STN STL	2.67	4.58	1.67	1.33	0.14	---	A0049-3-CF	85.00
1	180	COPPER	3.18	4.07	2.18	2.75	---	---	A0113-1-CF	90.00
1	55	NICKEL	3.18	4.07	2.18	2.75	---	---	A0113-5-CF	90.00
1	7	STN STL	3.18	4.07	2.18	2.75	---	---	A0113-3-CF	90.00
2	180	COPPER	3.18	4.07	2.18	2.75	---	0.75	A0065-1-CF	170.00
2	55	NICKEL	3.18	4.07	2.18	2.75	---	0.75	A0065-5-CF	170.00
2	7	STN STL	3.18	4.07	2.18	2.75	---	0.75	A0065-3-CF	170.00
3	180	COPPER	3.18	4.07	2.18	2.75	---	0.95	A0064-1-CF	225.00
3	55	NICKEL	3.18	4.07	2.18	2.75	---	0.95	A0064-5-CF	225.00
3	7	STN STL	3.18	4.07	2.18	2.75	---	0.95	A0064-3-CF	225.00
4	180	COPPER	3.18	4.07	2.18	2.75	---	0.95	A0063-1-CF	275.00
4	55	NICKEL	3.18	4.07	2.18	2.75	---	0.95	A0063-5-CF	275.00
4	7	STN STL	3.18	4.07	2.18	2.75	---	0.95	A0063-3-CF	275.00

See Section 7 for connectors, wiring, and other accessories.



5000 Volts DC / to 180 Amps / 1 to 4 Pins
QUICK FLANGE

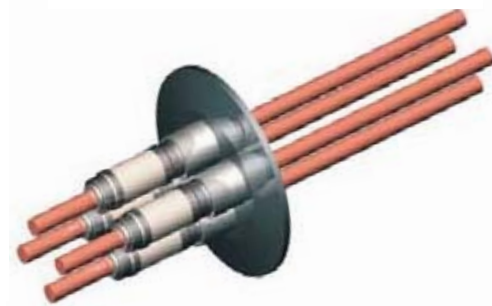
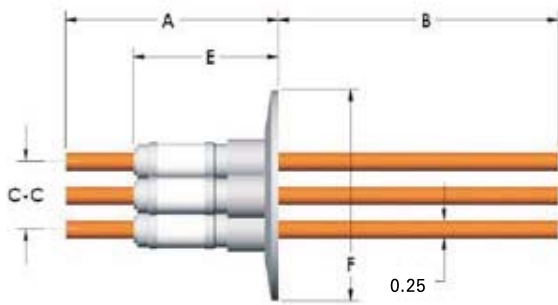
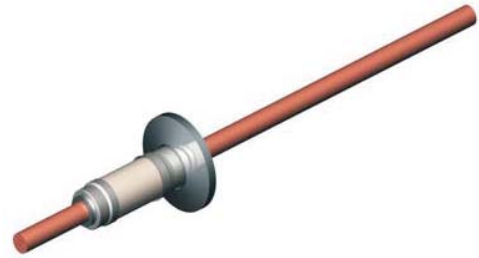
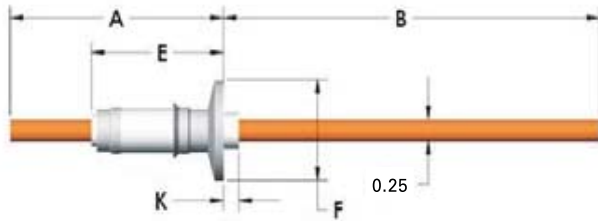

PINS	AMPS	CONDUCTOR	A	B	E	F	K	CC	PART #	PRICE
1	180	COPPER	2.60	4.65	1.60	1.18	0.23	---	A0117-1-QF	80.00
1	55	NICKEL	2.60	4.65	1.60	1.18	0.23	---	A0117-5-QF	80.00
1	7	STN STL	2.60	4.65	1.60	1.18	0.23	---	A0117-3-QF	80.00
1	180	COPPER	3.13	4.12	2.13	2.16	---	---	A0118-1-QF	85.00
1	55	NICKEL	3.13	4.12	2.13	2.16	---	---	A0118-5-QF	85.00
1	7	STN STL	3.13	4.12	2.13	2.16	---	---	A0118-3-QF	85.00
2	180	COPPER	3.13	4.12	2.13	2.16	---	0.75	A0114-1-QF	160.00
2	55	NICKEL	3.13	4.12	2.13	2.16	---	0.75	A0114-5-QF	160.00
2	7	STN STL	3.13	4.12	2.13	2.16	---	0.75	A0114-3-QF	160.00
3	180	COPPER	3.13	4.12	2.13	2.16	---	0.95	A0115-1-QF	215.00
3	55	NICKEL	3.13	4.12	2.13	2.16	---	0.95	A0115-5-QF	215.00
3	7	STN STL	3.13	4.12	2.13	2.16	---	0.95	A0115-3-QF	215.00
4	180	COPPER	3.13	4.12	2.13	2.95	---	0.95	A0116-1-QF	275.00
4	55	NICKEL	3.13	4.12	2.13	2.95	---	0.95	A0116-5-QF	275.00
4	7	STN STL	3.13	4.12	2.13	2.95	---	0.95	A0116-3-QF	275.00

See Section 7 for connectors, wiring, and other accessories.



8000 Volts DC / to 800 Amps / 1 Pin
WELDABLE

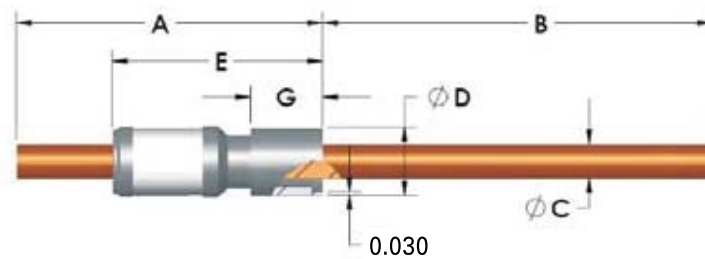

AMPS	CONDUCTOR	A	B	C	D	E	G	PART #	PRICE
800	COPPER	3.85	3.40	.75	1.12	2.80	0.75	A0122-2-W	145.00
250	NICKEL	3.85	3.40	.75	1.12	2.80	0.75	A0122-5-W	290.00
450	COPPER	3.80	3.40	.50	1.12	2.80	0.75	A8205-5-W	135.00
150	NICKEL	3.80	3.40	.50	1.12	2.80	0.75	A8205-4-W	190.00
300	COPPER	3.25	4.10	.38	.747	2.25	0.75	A0108-2-W	60.00
100	NICKEL	3.25	4.10	.38	.747	2.25	0.75	A0108-4-W	85.00

See Section 7 for connectors, wiring, and other accessories.



8000 Volts DC / to 800 Amps / 1 Pin
CONFLAT FLANGE

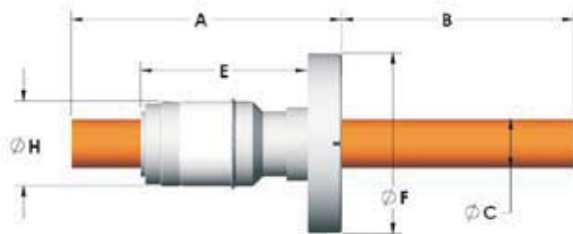

AMPS	CONDUCTOR	A	B	C	E	F	H	PART #	PRICE
800	COPPER	3.85	3.35	0.75	2.90	2.73	1.30	A0236-2-CF	200.00
250	NICKEL	3.85	3.35	0.75	2.90	2.73	1.30	A0236-5-CF	345.00
450	COPPER	3.85	3.35	0.50	2.90	2.73	1.30	A8206-5-CF	190.00
150	NICKEL	3.85	3.35	0.50	2.90	2.73	1.30	A8206-4-CF	245.00
300	COPPER	2.69	4.57	0.38	1.69	1.33	.78	A0221-2-CF	100.00
100	NICKEL	2.69	4.57	0.38	1.69	1.33	.78	A0221-4-CF	125.00

QUICK FLANGE

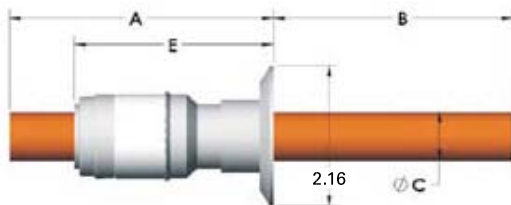

AMPS	CONDUCTOR	A	B	C	E	H	PART #	PRICE
800	COPPER	3.80	3.40	0.75	2.85	1.30	A0219-2-QF	200.00
250	NICKEL	3.80	3.40	0.75	2.85	1.30	A0219-5-QF	345.00
450	COPPER	3.80	3.40	0.50	2.85	1.30	A8207-5-QF	190.00
150	NICKEL	3.80	3.40	0.50	2.85	1.30	A8207-4-QF	245.00
300	COPPER	3.15	4.10	0.38	2.15	0.78	A0220-2-QF	100.00
100	NICKEL	3.15	4.10	0.38	2.15	0.78	A0220-4-QF	125.00

See Section 7 for connectors, wiring, and other accessories.



3000 Volts DC / to 250 Amps / 1 Pin
BASEPLATE

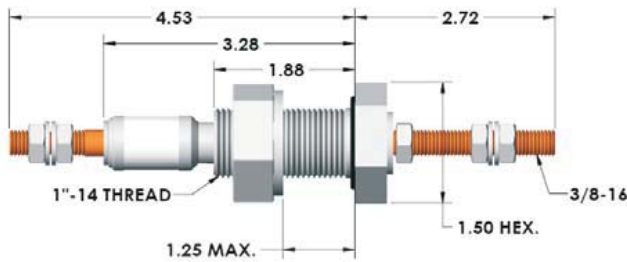

AMPS	CONDUCTOR	PART #	PRICE
250	COPPER	A0542-1-BP	195.00

5000 Volts DC / to 180 Amps / 1 Pin
BASEPLATE

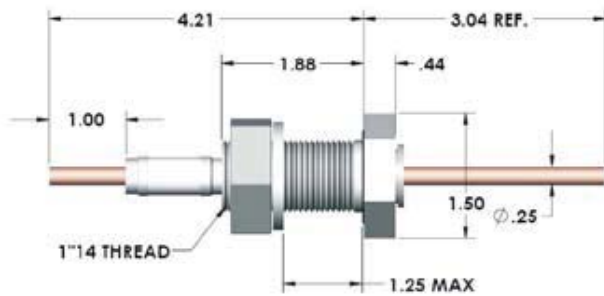

CONDUCTOR	AMPS	PART #	PRICE
COPPER	180	A0543-1-BP	165.00
NICKEL	55	A0543-2-BP	165.00
STN STL	7	A0543-3-BP	165.00

See Section 7 for connectors, wiring, and other accessories.



12,000 Volts DC / to 150 Amps / 1 Pin
1" BASEPLATE

Fig. 1

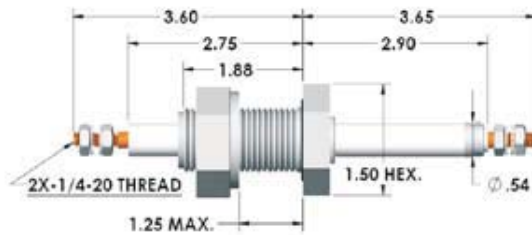
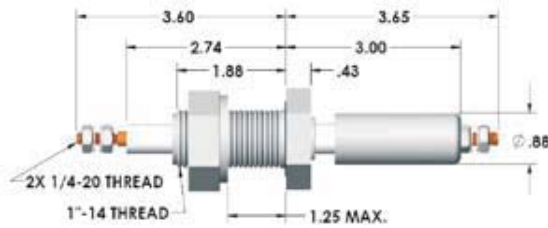

Fig. 2



TYPE	AMPS	CONDUCTOR	FIG	PART #	PRICE
EXPOSED	150	COPPER	1	A0544-1-BP	400.00
EXPOSED	75	NICKEL	1	A0544-2-BP	400.00
EXPOSED	7	STN STL	1	A0544-3-BP	400.00
SHIELDED	150	COPPER	2	A0545-1-BP	450.00
SHIELDED	75	NICKEL	2	A0545-2-BP	450.00
SHIELDED	7	STN STL	2	A0545-3-BP	450.00

See Section 7 for connectors, wiring, and other accessories.



10,000 Volts DC / to 50 Amps / 1 Pin
WELDABLE

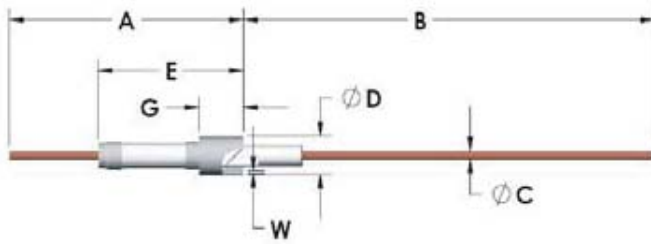

AMPS	CONDUCTOR	A	B	C	D	E	G	W	PART #	PRICE
50	COPPER	2.63	4.62	.094	.435	1.63	0.50	.030	A0066-5-W	35.00
15	NICKEL	2.63	4.62	.092	.435	1.63	0.50	.030	A0066-3-W	35.00

10,000 Volts DC / Ø Pins
WELDABLE

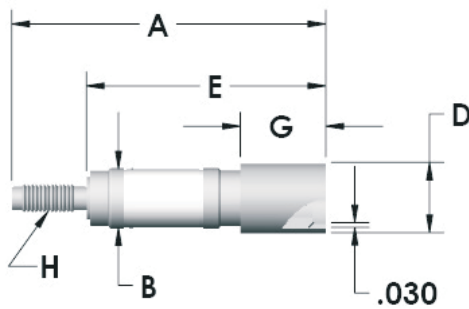

A	B	C	D	E	G	H	PART #	PRICE
2.79	.54	.150	.622	2.13	.75	.250-28	A0038-1-W	50.00

See Section 7 for connectors, wiring, and other accessories.



10,000 Volts DC / to 50 Amps / 1 to 4 Pins
CONFLAT FLANGE

Fig. 1

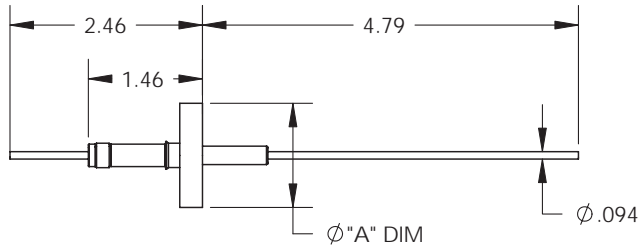
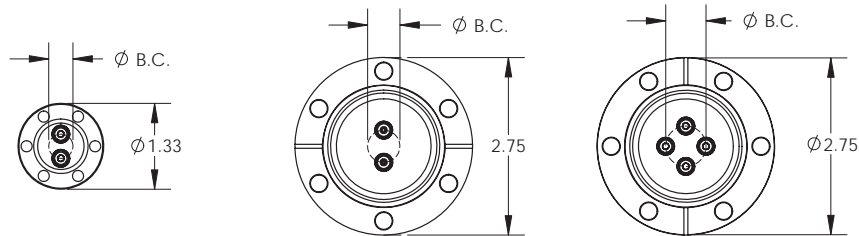
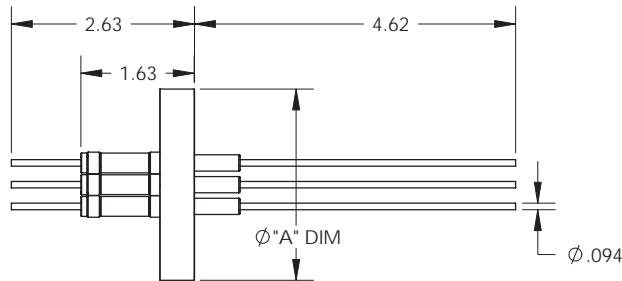

Fig. 2



PINS	AMPS	CONDUCTOR	FIG	Ø "A" DIM	Ø B.C.	PART #	PRICE
1	50	COPPER	1	1.33	---	A0043-5-CF	110.00
1	15	NICKEL	1	1.33	---	A0043-3-CF	110.00
1	50	COPPER	1	2.75	---	A0043-11-CF	115.00
2	50	COPPER	2	1.33	.38	A0042-3-CF	165.00
2	15	NICKEL	2	1.33	.38	A0042-1-CF	165.00
2	50	COPPER	2	2.75	.50	A0044-3-CF	170.00
2	15	NICKEL	2	2.75	.50	A0044-1-CF	170.00
4	50	COPPER	2	2.75	.62	A0045-3-CF	225.00
4	15	NICKEL	2	2.75	.62	A0045-1-CF	225.00

See Section 7 for connectors, wiring, and other accessories.



10,000 Volts DC / to 50 Amps / 1 to 4 Pins
QUICK FLANGE

Fig. 1

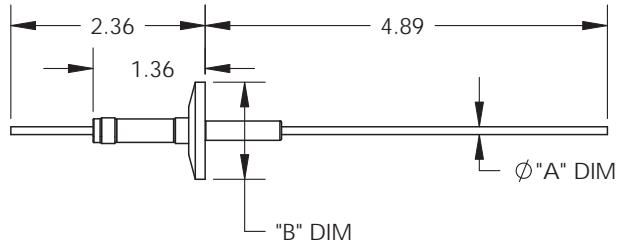
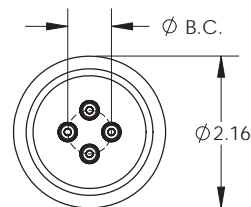
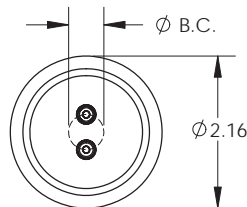
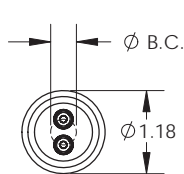
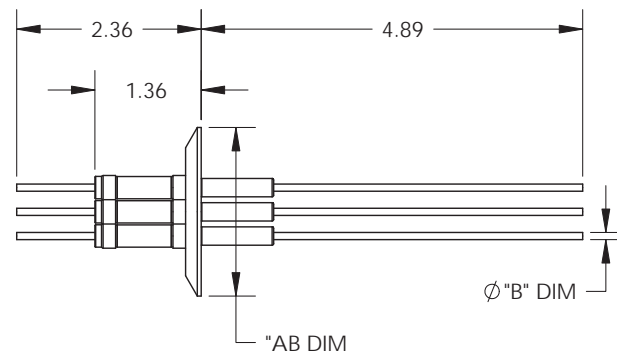

Fig. 2



PINS	AMPS	CONDUCTOR	FIG	"A" DIM	ϕ "B" DIM	ϕ B.C.	PART #	PRICE
1	50	COPPER	1	.094	1.18	---	A0508-2-QF	110.00
1	15	NICKEL	1	.092	1.18	---	A0508-1-QF	110.00
2	50	COPPER	1	.094	1.18	.39	A0781-2-QF	165.00
2	15	NICKEL	1	.092	1.18	.39	A0781-1-QF	165.00
2	50	COPPER	2	.094	2.16	.50	A0507-2-QF	170.00
2	15	NICKEL	2	.092	2.16	.50	A0507-1-QF	170.00
4	50	COPPER	2	.094	2.16	.62	A0506-2-QF	225.00
4	15	NICKEL	2	.092	2.16	.62	A0506-1-QF	225.00

See Section 7 for connectors, wiring, and other accessories.



12,000 Volts DC / to 180 Amps / 1 Pin

WELDABLE

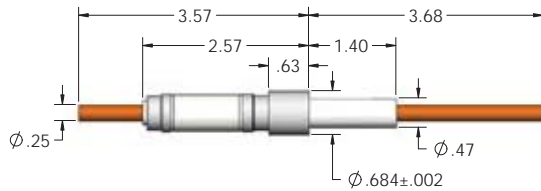

AMPS	CONDUCTOR	PART #	PRICE
180	COPPER	A0548-1-W	100.00
55	NICKEL	A0548-3-W	100.00
7	STN STL	A0548-2-W	100.00

12,000 Volts DC / to 180 Amps / 1 or 2 Pins

CONFLAT FLANGE

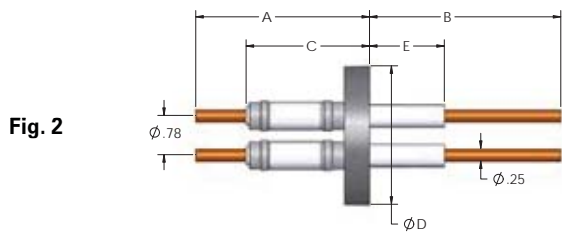
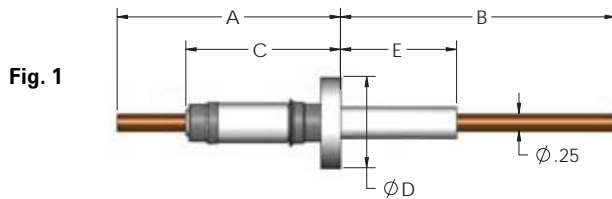

PINS	AMPS	CONDUCTOR	FIG	A	B	C	D	E	PART #	PRICE
1	180	COPPER	1	3.25	4.00	2.25	1.33	1.69	A0549-1-CF	190.00
1	55	NICKEL	1	3.25	4.00	2.25	1.33	1.69	A0549-3-CF	190.00
1	7	STN STL	1	3.25	4.00	2.25	1.33	1.69	A0549-2-CF	190.00
1	180	COPPER	1	3.61	3.23	2.61	2.75	1.35	A0551-1-CF	190.00
1	55	NICKEL	1	3.61	3.23	2.61	2.75	1.35	A0551-3-CF	190.00
1	7	STN STL	1	3.61	3.23	2.61	2.75	1.35	A0551-2-CF	190.00
2	180	COPPER	2	3.61	3.23	2.61	2.75	1.35	A0550-1-CF	400.00
2	55	NICKEL	2	3.61	3.23	2.61	2.75	1.35	A0550-3-CF	400.00
2	7	STN STL	2	3.61	3.23	2.61	2.75	1.35	A0550-2-CF	400.00

See Section 7 for connectors, wiring, and other accessories.



20,000 Volts DC / to 50 Amps / 1 Pin
WELDABLE

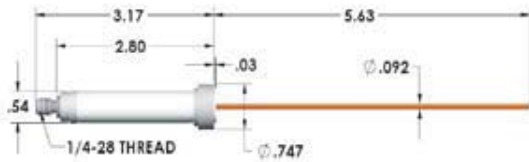

AMPS	CONDUCTOR	PART #	PRICE
15	NICKEL	A0531-1-W	80.00
50	COPPER	A0531-2-W	80.00

CONFLAT FLANGE

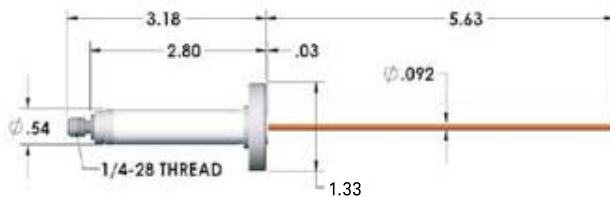

AMPS	CONDUCTOR	PART #	PRICE
15	NICKEL	A0533-1-CF	110.00
50	COPPER	A0533-2-CF	110.00

QUICK FLANGE

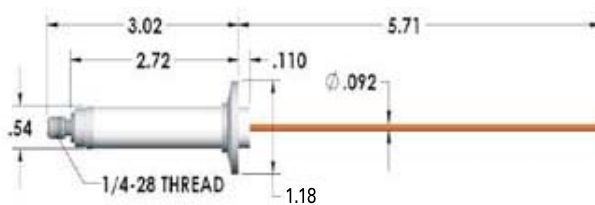

AMPS	CONDUCTOR	PART #	PRICE
15	NICKEL	A0532-1-QF	110.00
50	COPPER	A5743-1-QF	110.00

See Section 7 for connectors, wiring, and other accessories.



20,000 to 30,000 Volts DC / to 50 Amps / 1 Pin
WELDABLE

Fig. 1

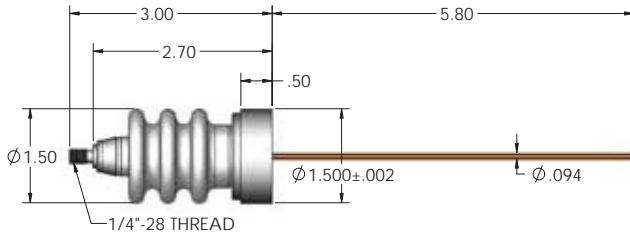

Fig. 2

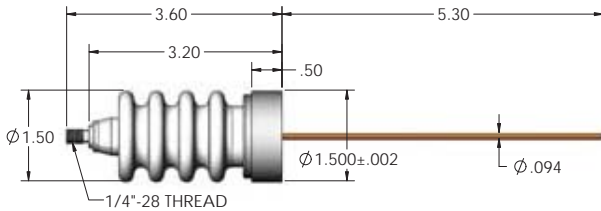
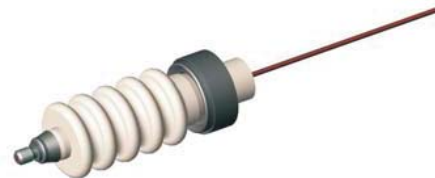
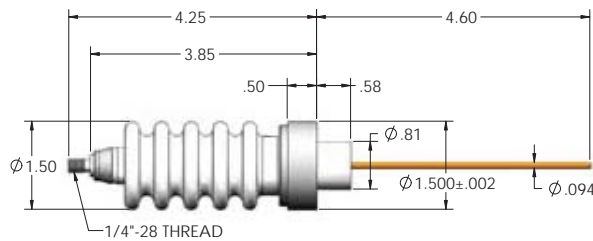

Fig. 3



VOLTS	AMPS	CONDUCTOR	FIG	PART #	PRICE
20KV	3	STN STL	1	A0232-1-W	130.00
20KV	50	COPPER	1	A0232-2-W	130.00
25KV	3	STN STL	2	A0231-1-W	145.00
25KV	50	COPPER	2	A0231-2-W	145.00
30KV	3	STN STL	3	A0230-1-W	145.00
30KV	50	COPPER	3	A0230-2-W	145.00
30KV	15	NICKEL	3	A0230-3-W	145.00

See Section 7 for connectors, wiring, and other accessories.



20,000 to 30,000 Volts DC / to 50 Amps / 1 Pin CONFLAT FLANGE

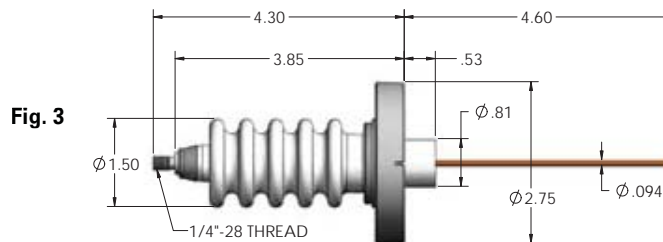
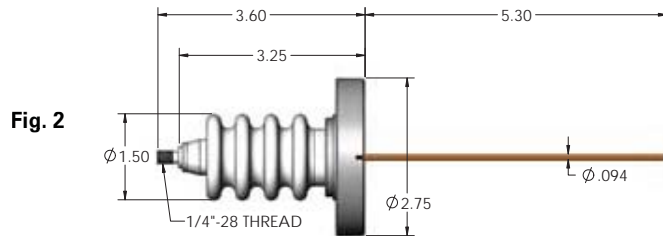
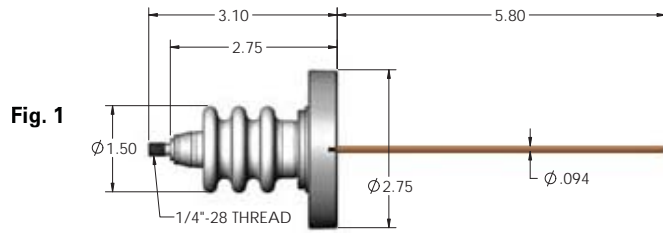

VOLTS	AMPS	CONDUCTOR	MOUNT	FIG	PART #	PRICE
20KV	3	STN STL	CF40	1	A0234-1-CF	210.00
20KV	50	COPPER	CF40	1	A0234-2-CF	210.00
25KV	3	STN STL	CF40	2	A0234-3-CF	225.00
25KV	50	COPPER	CF40	2	A0234-4-CF	225.00
30KV	3	STN STL	CF40	3	A0234-5-CF	200.00
30KV	50	COPPER	CF40	3	A0234-6-CF	200.00

See Section 7 for connectors, wiring, and other accessories.



20,000 to 30,000 Volts DC / to 180 Amps / 1 or 2 Pins
WELDABLE

Fig. 1

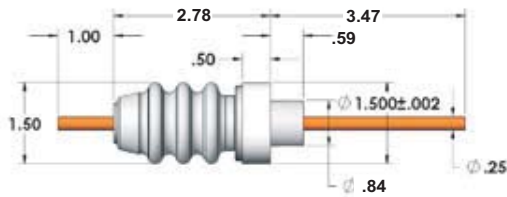

Fig. 2

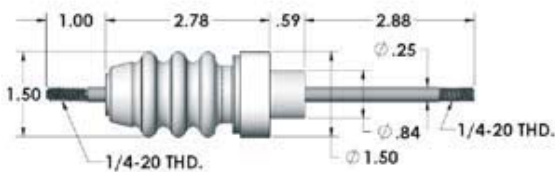
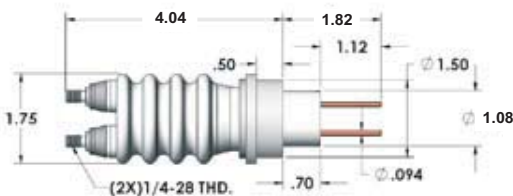

Fig. 3



VOLTS	AMPS	CONDUCTOR	FIG	PART #	PRICE
20KV	180	COPPER	1	A0658-1-W	175.00
20KV	55	NICKEL	1	A0658-2-W	175.00
20KV	150	COPPER	2	A7000-1-W	225.00
20KV	50	NICKEL	2	A7000-2-W	225.00
20KV	7	STN STL	2	A7000-3-W	225.00
30KV	50	COPPER	3	A2090-1-W	345.00

See Section 7 for connectors, wiring, and other accessories.



25,000 Volts DC / to 50 Amps / 3 Pins
WELDABLE

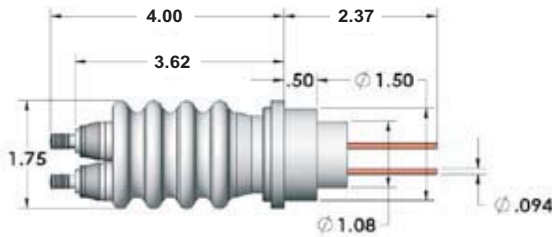

AMPS	CONDUCTOR	PART #	PRICE
50	COPPER	A3882-1-W	450.00
3	STN STL	A3882-4-W	450.00

60,000 Volts DC / 3 Amps / 1 Pin
WELDABLE

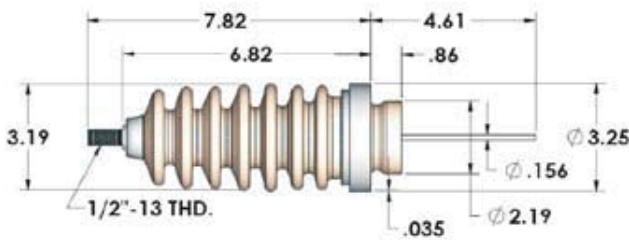

CONDUCTOR	PART #	PRICE
STN STL	A3106-1-W	750.00

See Section 7 for connectors, wiring, and other accessories.



20,000 to 30,000 Volts DC / 7 to 180 Amps / 1 or 2 Pins
CONFLAT FLANGE

Fig. 1

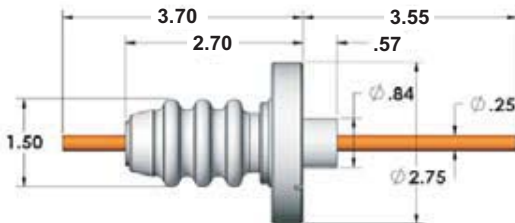

Fig. 2

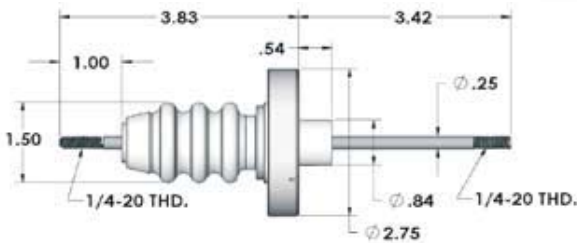
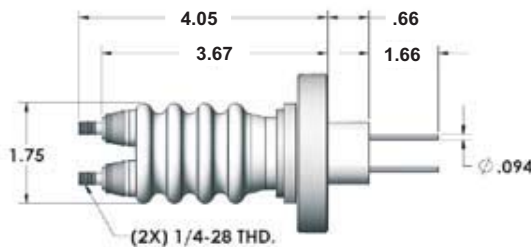

Fig. 3



VOLTS	AMPS	CONDUCTOR	MOUNT	FIG	PART #	PRICE
20KV	180	COPPER	CF40	1	A1158-1-CF	250.00
20KV	55	NICKEL	CF40	1	A1158-2-CF	250.00
20KV	150	COPPER	CF40	2	A7001-1-CF	300.00
20KV	50	NICKEL	CF40	2	A7001-2-CF	300.00
20KV	7	NICKEL	CF40	2	A7001-3-CF	300.00
30KV	50	COPPER	CF40	3	A2089-1-CF	425.00

See Section 7 for connectors, wiring, and other accessories.



25,000 Volts DC / 50 Amps / 3 Pins
CONFLAT FLANGE

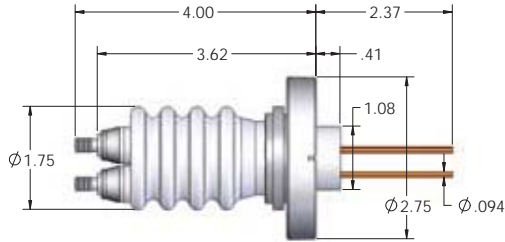

CONDUCTOR	MOUNT	PART #	PRICE
COPPER	CF40	A6203-1-CF	530.00

60,000 Volts DC / 3 Amps / 1 Pin
CONFLAT FLANGE

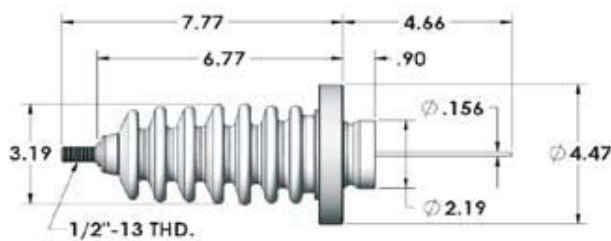

CONDUCTOR	MOUNT	PART #	PRICE
STN STL	CF63	A3107-1-CF	930.00

See Section 7 for connectors, wiring, and other accessories.



40,000 Volts DC / to 7 Amps / 1 Pin

Air-side Connector and Cable Included

WELDABLE

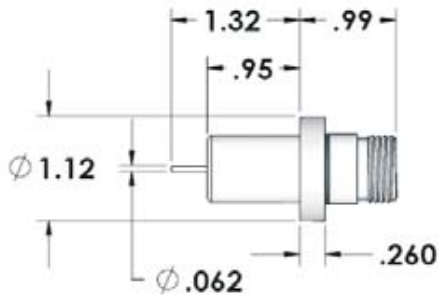

QUICK FLANGE

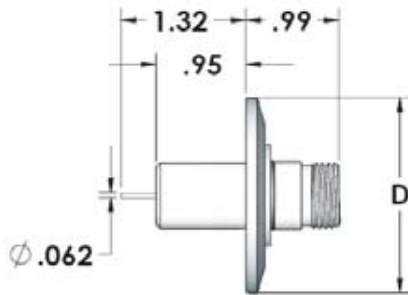

CONFLAT FLANGE

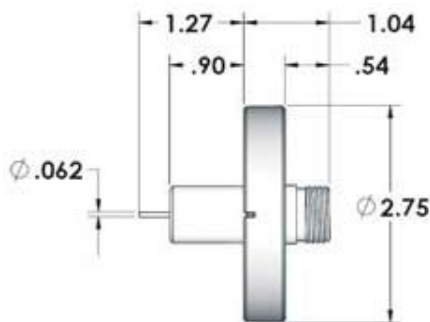

MOUNT	D	PART #	PRICE
WELDABLE	---	A2607-1-W	525.00
QF40	2.16	A2606-1-QF	565.00
QF50	2.95	A2606-2-QF	565.00
CF40	---	A2605-1-CF	565.00
CONNECTOR	---	A2608-1-CN	220.00

See Section 7 for connectors, wiring, and other accessories.



Water-Cooled — 5000 to 8000 Volts DC / 1 Tube
WELDABLE

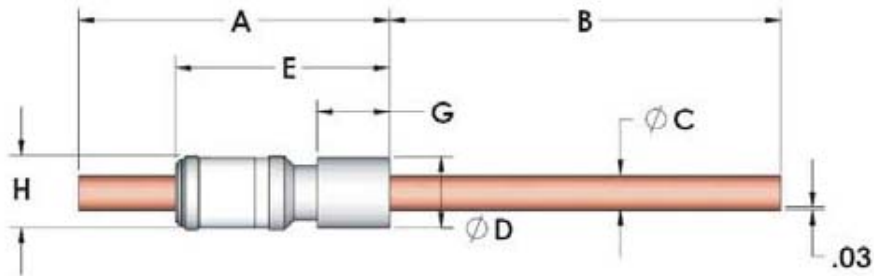

VOLTS	CONDUCTOR	A	B	C	D	E	G	H	PART #	PRICE
5KV	COPPER	3.13	4.12	0.25	.622	2.13	0.75	0.54	A0106-4-W	55.00
5KV	NICKEL	3.13	4.12	0.25	.622	2.13	0.75	0.54	A0106-6-W	65.00
5KV	STN STL	3.13	4.12	.25	.622	2.13	.75	.54	A0106-5-W	55.00
8KV	COPPER	3.80	3.40	0.75	1.12	2.85	0.75	1.30	A0122-1-W	140.00
8KV	COPPER	3.80	3.40	0.50	1.12	2.85	0.75	1.30	A8205-2-W	130.00
8KV	COPPER	3.15	4.10	0.38	.747	2.15	0.75	0.78	A0108-1-W	70.00



Water-Cooled — 5000 to 8000 Volts DC / 1 to 4 Tubes
CONFLAT FLANGE

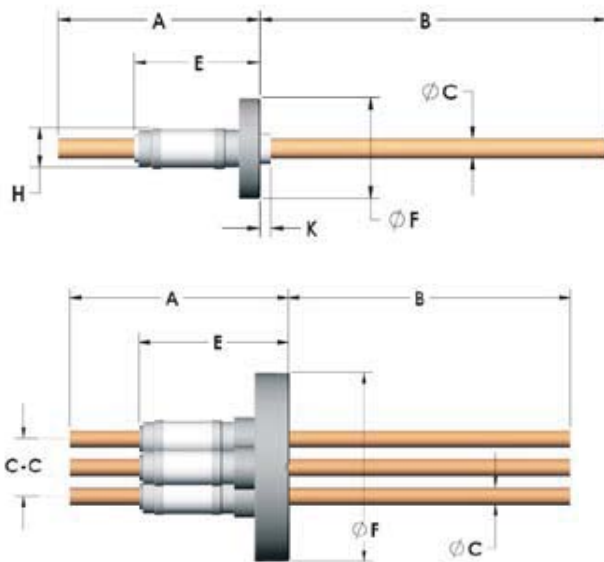

PINS	VOLTS	CONDUCTOR	A	B	C	E	F	H	K	CC	PART #	PRICE
1	5KV	COPPER	2.67	4.58	.25	1.67	1.33	.54	.14	---	A0049-2-CF	85.00
1	5KV	NICKEL	2.67	4.58	.25	1.67	1.33	.54	.14	---	A0049-6-CF	95.00
1	5KV	STN STL	2.67	4.58	.25	1.67	1.33	.54	.14	---	A0049-4-CF	85.00
1	5KV	COPPER	3.18	4.07	.25	2.18	2.75	.54	---	---	A0113-2-CF	90.00
1	5KV	NICKEL	3.18	4.07	.25	2.18	2.75	.54	---	---	A0113-6-CF	100.00
1	5KV	STN STL	3.18	4.12	.25	2.18	2.75	.54	---	---	A0113-4-CF	90.00
1	8KV	COPPER	3.80	3.40	.75	2.90	2.75	1.30	---	---	A0236-1-CF	190.00
1	8KV	COPPER	3.80	3.40	.50	2.90	2.75	1.30	---	---	A8206-2-CF	180.00
1	8KV	COPPER	2.69	4.57	.38	1.69	1.33	.78	---	---	A0221-1-CF	110.00
2	5KV	COPPER	3.18	4.12	.25	2.18	2.75	.54	---	.75	A0065-2-CF	160.00
2	5KV	NICKEL	3.18	4.07	.25	2.18	2.75	.54	---	.75	A0065-6-CF	180.00
2	5KV	STN STL	3.18	4.07	.25	2.18	2.75	.54	---	.75	A0065-4-CF	160.00
3	5KV	COPPER	3.18	4.07	.25	2.18	2.75	.54	---	.95	A0064-2-CF	225.00
3	5KV	NICKEL	3.18	4.12	.25	2.18	2.75	.54	---	.95	A0064-6-CF	250.00
3	5KV	STN STL	3.18	4.12	.25	2.18	2.75	.54	---	.95	A0064-4-CF	225.00
4	5KV	COPPER	3.18	4.12	.25	2.18	2.75	.54	---	.95	A0063-2-CF	275.00
4	5KV	NICKEL	3.18	4.12	.25	2.18	2.75	.54	---	.95	A0063-6-CF	305.00
4	5KV	STN STL	3.18	4.12	.25	2.18	2.75	.54	---	.95	A0063-4-CF	275.00

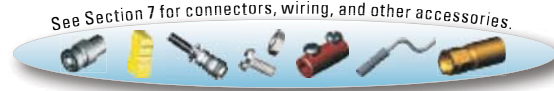

Water-Cooled — 5000 to 8000 Volts DC / 1 to 4 Tubes QUICK FLANGE

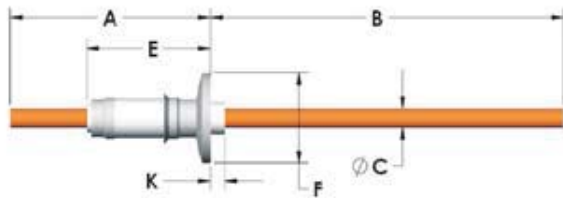
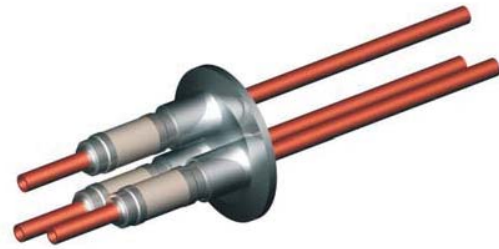
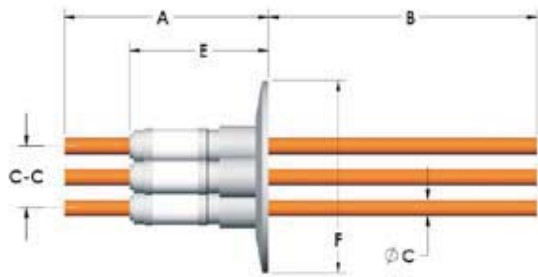

PINS	VOLTS	CONDUCTOR	A	B	C	E	F	H	K	CC	PART #	PRICE
1	5KV	COPPER	2.60	4.65	.25	1.60	1.18	.54	.23	---	A0117-2-QF	80.00
1	5KV	NICKEL	2.60	4.65	.25	1.60	1.18	.54	.23	---	A0117-6-QF	90.00
1	5KV	STN STL	2.60	4.65	.25	1.60	1.18	.54	.23	---	A0117-4-QF	80.00
1	5KV	COPPER	3.13	4.12	.25	2.13	2.16	.54	---	---	A0118-2-QF	85.00
1	5KV	NICKEL	3.13	4.12	.25	2.13	2.16	.54	---	---	A0118-6-QF	95.00
1	5KV	STN STL	3.13	4.12	.25	2.13	2.16	.54	---	---	A0118-4-QF	85.00
1	8KV	COPPER	3.80	3.40	.75	2.85	2.16	1.30	---	---	A0219-1-QF	190.00
1	8KV	COPPER	3.80	3.40	.50	2.85	2.16	1.30	---	---	A8207-2-QF	180.00
1	8KV	COPPER	3.15	4.10	.38	2.15	2.16	.78	---	---	A0220-1-QF	110.00
2	5KV	COPPER	3.13	4.12	.25	2.13	2.16	.54	---	.75	A0114-2-QF	160.00
2	5KV	NICKEL	3.13	4.12	.25	2.13	2.16	.54	---	.75	A0114-6-QF	180.00
2	5KV	STN STL	3.13	4.12	.25	2.13	2.16	.54	---	.75	A0114-4-QF	160.00
3	5KV	COPPER	3.13	4.12	.25	2.13	2.16	.54	---	.95	A0115-2-QF	215.00
3	5KV	NICKEL	3.13	4.12	.25	2.13	2.16	.54	---	.95	A0115-6-QF	240.00
3	5KV	STN STL	3.13	4.12	.25	2.13	2.16	.54	---	.95	A0115-4-QF	215.00
4	5KV	COPPER	3.13	4.12	.25	2.13	2.95	.54	---	.95	A0116-2-QF	275.00
4	5KV	NICKEL	3.13	4.12	.25	2.13	2.95	.54	---	.95	A0116-6-QF	295.00
4	5KV	STN STL	3.13	4.12	.25	2.13	2.95	.54	---	.95	A0116-4-QF	275.00

See Section 7 for connectors, wiring, and other accessories.



Water-Cooled — 5000 to 8000 Volts DC / 1 Tube
NPT PIPE THREAD

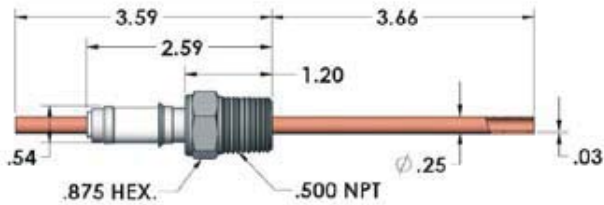

PINS	CONDUCTOR	PART #	PRICE
1	COPPER	A0003-2-NPT	115.00
1	NICKEL	A0003-6-NPT	115.00
1	STN STL	A0003-4-NPT	115.00

8000 Volts DC / 1000 Amps / 1 Pin
CONFLAT FLANGE

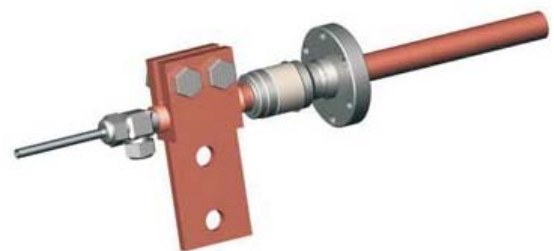
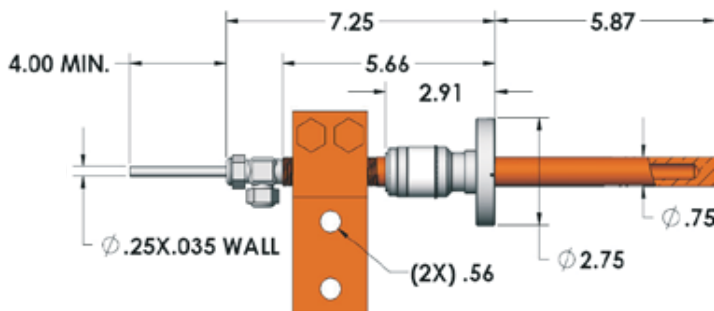

FLANGE	CONDUCTOR	PART #	PRICE
CF40	COPPER	A2100-1-CF	750.00

See Section 7 for connectors, wiring, and other accessories.



Water-Cooled — 50 Volts DC / 1000 Amps
BASEPLATE

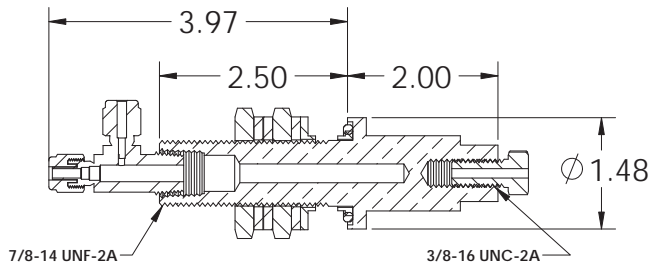

CONDUCTOR	PART #	PRICE
COPPER	A1658-1-BP	205.00

Solid Conductor — 50 Volts DC / 400 Amps

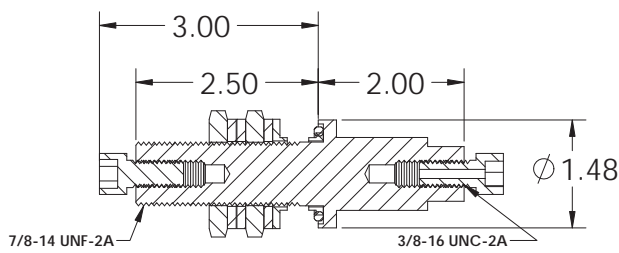

CONDUCTOR	PART #	PRICE
COPPER	A1745-1-BP	180.00

See Section 7 for connectors, wiring, and other accessories.



RF – 8 KV / 10 KW / 1 Conductor
WELDABLE

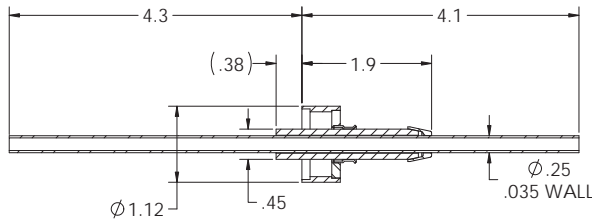

PART #	PRICE
A0561-1-W	230.00

CONFLAT FLANGE

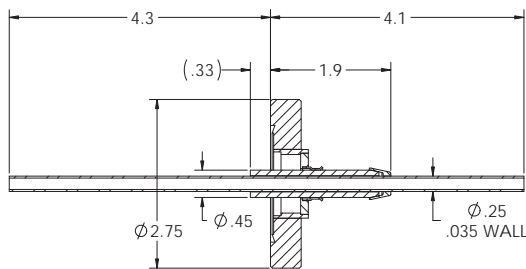

PART #	PRICE
A0563-1-CF	250.00

QUICK FLANGE

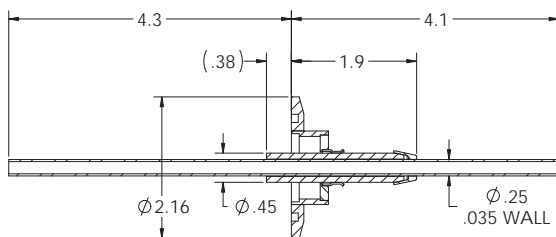

PART #	PRICE
A0564-1-QF	250.00

See Section 7 for connectors, wiring, and other accessories.



RF — 8 KV / 10 KW / 2 Conductors
WELDABLE

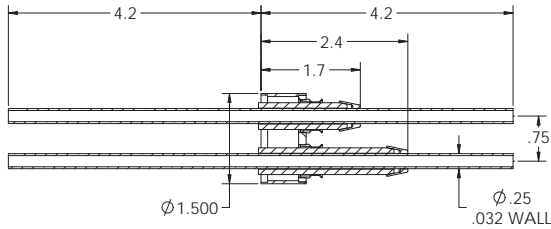

PART #	PRICE
A0553-1-W	270.00

CONFLAT FLANGE

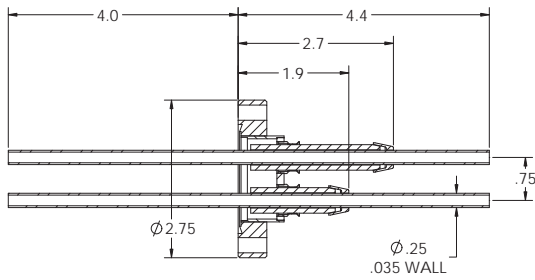

PART #	PRICE
A0559-1-CF	290.00

QUICK FLANGE

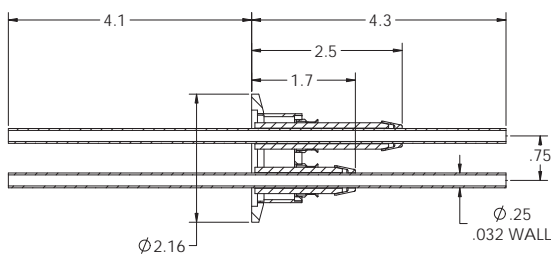

PART #	PRICE
A0565-1-QF	290.00

See Section 7 for connectors, wiring, and other accessories.



5000 Volts DC / to 30 Amps / 1 to 4 Pins
Power Glove Connector Included (96" length)

WELDABLE

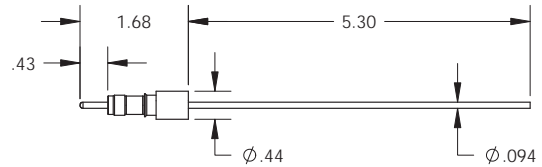

AMPS	CONDUCTOR	PART #	PRICE
30	OFHC COPPER	A2118-1-W	75.00
15	NICKEL - 200	A2118-2-W	75.00
1	304 STN STL	A2118-3-W	75.00

CONFLAT FLANGE

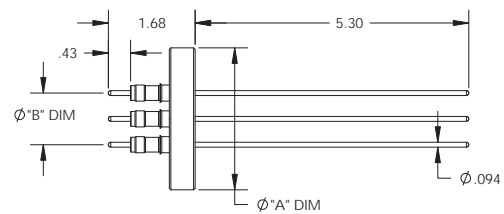

PINS	CONDUCTOR	Ø "A" DIM	Ø "B" DIM	PART #	PRICE
1	OFHC COPPER	1.33	---	A2597-1-CF	130.00
1	OFHC COPPER	2.75	---	A2597-2-CF	140.00
2	OFHC COPPER	2.75	1.00	A2207-1-CF	215.00
4	OFHC COPPER	2.75	1.00	A1836-1-CF	365.00

QUICK FLANGE

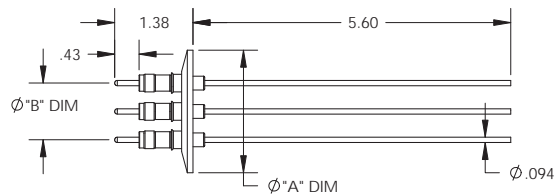

PINS	CONDUCTOR	Ø "A" DIM	Ø "B" DIM	PART #	PRICE
1	OFHC COPPER	1.57	---	A5969-1-QF	130.00
1	OFHC COPPER	2.16	---	A5970-1-QF	140.00
2	OFHC COPPER	2.16	1.00	A5971-1-QF	215.00
4	OFHC COPPER	2.16	1.00	A5972-1-QF	365.00

See Section 7 for connectors, wiring, and other accessories.



10,000 Volts DC / to 30 Amps / 1 to 4 Pins

Power Glove Connector Included (96" length)

WELDABLE

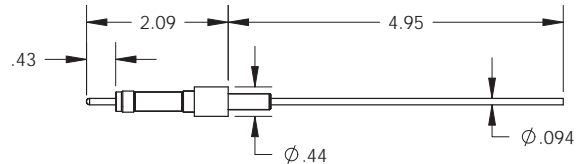

AMPS	CONDUCTOR	PART #	PRICE
30	OFHC COPPER	A2535-1-W	85.00
15	NICKEL - 200	A2535-2-W	85.00
1	304 STN STL	A2535-3-W	85.00

CONFLAT FLANGE

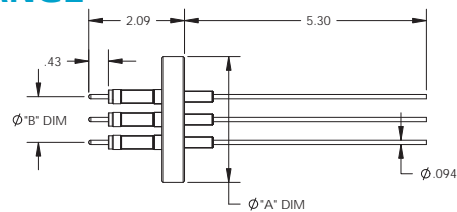
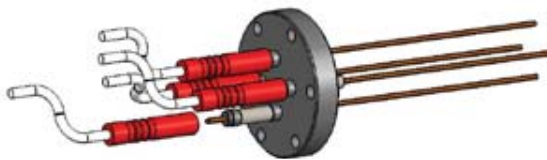

PINS	CONDUCTOR	Ø "A" DIM	Ø "B" DIM	PART #	PRICE
1	OFHC COPPER	1.33	---	A2523-1-CF	145.00
1	OFHC COPPER	2.75	---	A2523-2-CF	155.00
2	OFHC COPPER	2.75	1.00	A2523-3-CF	245.00
4	OFHC COPPER	2.75	1.00	A2523-4-CF	425.00

QUICK FLANGE

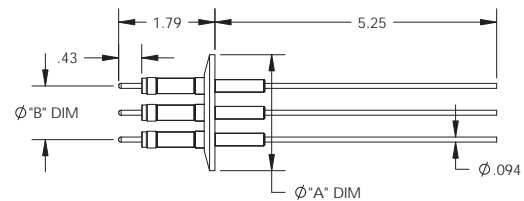
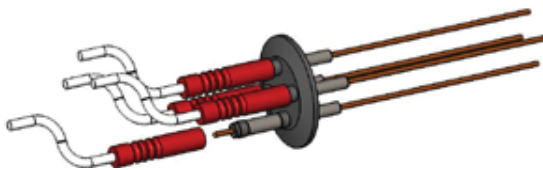

PINS	CONDUCTOR	Ø "A" DIM	Ø "B" DIM	PART #	PRICE
1	OFHC COPPER	1.57	---	A5975-1-QF	145.00
1	OFHC COPPER	2.16	---	A5976-1-QF	155.00
2	OFHC COPPER	2.16	1.00	A5977-1-QF	245.00
4	OFHC COPPER	2.16	1.00	A5978-1-QF	425.00

See Section 7 for connectors, wiring, and other accessories.



20,000 Volts DC / to 30 Amps / 1 to 4 Pins
Power Glove Connector Included (96" length)

WELDABLE

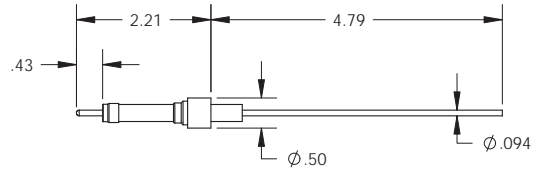

AMPS	CONDUCTOR	PART #	PRICE
30	OFHC COPPER	A7501-1-W	90.00
15	NICKEL - 200	A7501-2-W	90.00
1	304 STN STL	A7501-3-W	90.00

CONFLAT FLANGE

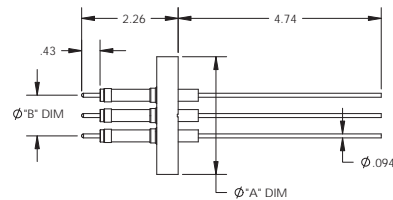
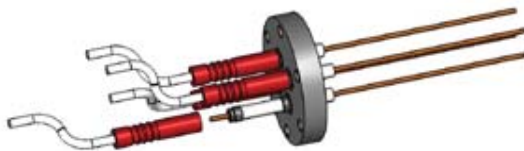

PINS	CONDUCTOR	Ø "A" DIM	Ø "B" DIM	PART #	PRICE
1	OFHC COPPER	1.33	---	A5979-1-CF	150.00
1	OFHC COPPER	2.75	---	A5980-1-CF	160.00
2	OFHC COPPER	2.75	0.95	A5981-1-CF	255.00
4	OFHC COPPER	2.75	0.95	A5982-1-CF	445.00

QUICK FLANGE

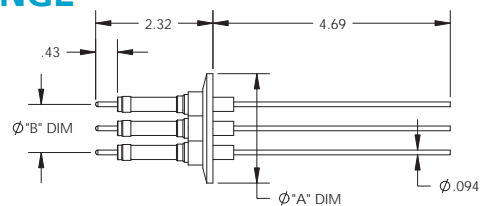
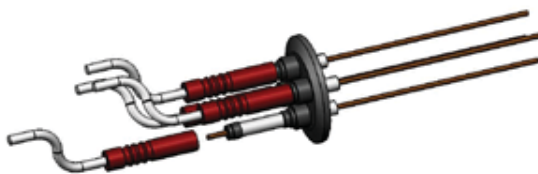

PINS	CONDUCTOR	Ø "A" DIM	Ø "B" DIM	PART #	PRICE
1	OFHC COPPER	1.57	---	A5983-1-QF	150.00
1	OFHC COPPER	2.16	---	A5984-1-QF	160.00
2	OFHC COPPER	2.16	0.95	A5985-1-QF	255.00
4	OFHC COPPER	2.16	0.95	A5986-1-QF	445.00

See Section 7 for connectors, wiring, and other accessories.

