

THERMOCOUPLE

Thermocouple is the description for electrical feedthroughs that are commonly used for temperature measurement systems. A thermocouple feedthrough does not measure temperature, but rather it is used to conduct the thermocouple's voltage signal from inside the vacuum system to an external instrumentation device. MPF uses ceramic-to-metal sealing technology to braze various metals used in thermocouple assemblies to high purity alumina ceramic insulators. Thermocouple feedthroughs are suitable for ultra high vacuum applications.

MPF offers several mounting options for all standard products: Weldable, Quick Flange (QF), and Conflat Flange (CF). Most designs are also configured for Baseplate and NPT style adapters. Custom adapters, plates and flange configurations are available by request.

Miniature & Screw Type Connectors

The most popular Thermocouple connections are miniature and screw type connections, which are commonly used in many thermocouple applications. MPF offers miniature connectors for C, E, J and K type thermocouples. N, R, S and T type thermocouples require a screw and nut connection.

MS Connectors

Industry standard threaded connectors are available E, J and K type thermocouples. MS Connectors provide high pin density and convenient circular style connectors for the air and vacuum sides, which accommodate up to 10 pairs of thermocouple leads.

Thermocouple and Power Combination

Many applications involve power leads to drive a process and the need for process control information provided by thermocouples. MPF offers several standard designs which combine thermocouple and power feedthroughs into a single assembly.



Thermocouple Reference Table

Type	Thermocouple Material	Polarity	Operating Temperature Range
 K	Chromel Alumel	+ -	-184 to 1260°C
 C	Tungsten 5% Rhenium Tungsten 26% Rhenium	+ -	0 to 2760°C
 E	Chromel Constantan	+ -	-184 to 900°C
 J	Iron Constantan	+ -	0 to 750°C
 T	Copper Constantan	+ -	-184 to 400°C
 N	NI-CR-SI NI-SI-MG	+ -	-270 to 1300°C
 R	Platinum 13% Rhodium Platinum	+ -	0 to 1540°C
 S	Platinum 10% Rhodium Platinum	+ -	0 to 1540°C

Thermocouple

Section 3: Contents

Section	Type	Electrical Rating	Thermal Rating	Pages
3.1	Single Leg Pairs Screw and Nut Connections Miniature Connector Types: C*, E, J and K	Voltage: Milli-Volts Current: Milli-Amps	Feedthrough: -100 to 450°C Air-side Connector: -65 to 125°C	46
3.2	Connector Fitted 1, 2, 3, 4 and 5 Thermocouple Pairs Types: C*, E, J and K	Voltage: Milli-Volts Current: Milli-Amps	Feedthrough: -100 to 450°C Air-side Connector: -65 to 125°C	47-54
3.3	Screw Type Connection 1, 2, 3, 4 and 5 Thermocouple Pairs Types: N*, R*, S* and T*	Voltage: Milli-Volts Current: Milli-Amps	Feedthrough: -100 to 450°C	55-62
3.4	MS Connectors 2, 3, 5 and 10 Thermocouple Pairs Types: E, J and K Single and Double-ended	Voltage: Milli-Volts Current: Milli-Amps	Feedthrough: -100 to 450°C Air-side Connector: -65 to 125°C Vacuum Connector: -100 to 350°C	63-67
3.5	Push-On Connectors 2, 3 and 5 Thermocouple Pairs Types: E, J and K	Voltage: Milli-Volts Current: Milli-Amps	Feedthrough: -100 to 450°C	68-69
3.6	Thermocouple / Power 1 T/C Pair + 2 Power Pins 1 or 2 T/C Pairs + 3 Power Pins 1 or 2 T/C Pairs + 2 Power Pins Types: C*, E, J and K	Voltage: to 5000 Volts DC (Power) Current: to 150 Amps (Power)	Feedthrough: -100 to 450°C Air-side Connector: -65 to 125°C	70-74

* Note: C, N, R, S and T use extension grade materials

Operating Conditions

The electrical and thermal ratings specified are safe operating limits determined by various factors including material properties, mechanical design, and the intended operating environment. All electrical ratings are based on operation with one side in dry atmosphere and the other side in vacuum of 1×10^{-4} Torr maximum pressure. Temperature ratings for various mounting options may reduce the operating range of an assembly. All assemblies have a maximum thermal gradient of 25°C per minute and may be damaged if this limit is exceeded.

1 Pair Screw and Nut Connections Single Leg T/C Pairs

Air and Vacuum-side Connectors Included

WELDABLE

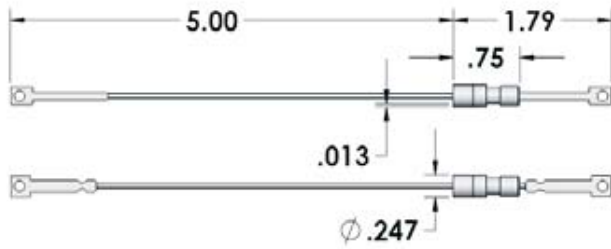

TYPE	PART #	PRICE
K	A0802-1-W	82.00
C	A0802-2-W	82.00
J	A0802-3-W	82.00
E	A0802-4-W	82.00

Miniature Connector Single Leg T/C Pairs

Air and Vacuum-side Connectors Included

WELDABLE

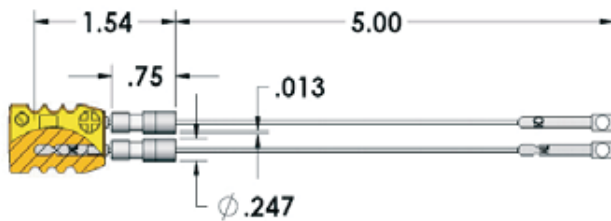

TYPE	PART #	PRICE
K	A0636-1-W	82.00
C	A0636-2-W	82.00
J	A0636-3-W	82.00
E	A0636-4-W	82.00

See Section 7 for connectors, wiring, and other accessories.



1 to 3 Pairs — Connector Fitted

Air and Vacuum-side Connectors Included

WELDABLE

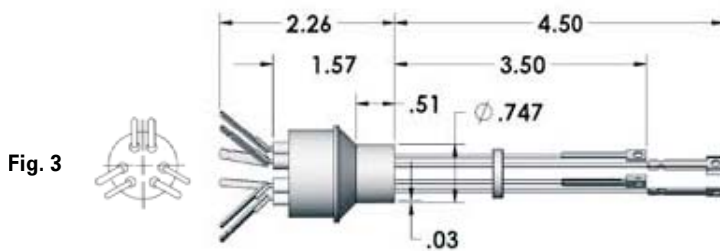
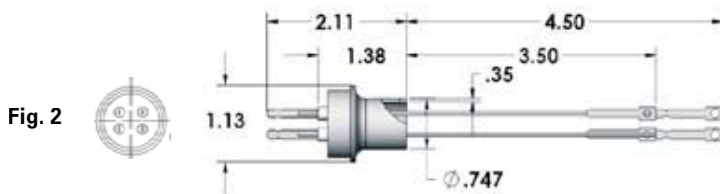
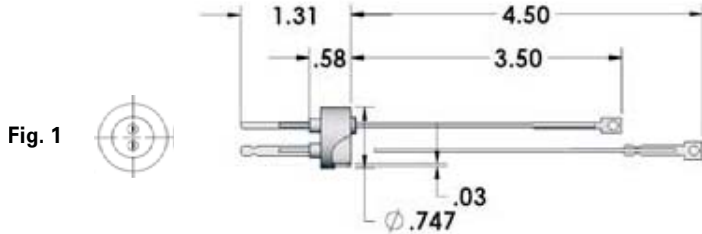

# PAIRS	TYPE	FIG	PART #	PRICE
1	C	1	A0389-1-W	75.00
1	E	1	A0390-1-W	75.00
1	J	1	A0387-1-W	75.00
1	K	1	A0388-1-W	75.00
2	C	2	A0406-3-W	135.00
2	E	2	A0406-4-W	135.00
2	J	2	A0406-1-W	135.00
2	K	2	A0406-2-W	135.00
3	C	3	A0661-4-W	215.00
3	E	3	A0661-3-W	215.00
3	J	3	A0661-2-W	215.00
3	K	3	A0661-1-W	215.00

See Section 7 for connectors, wiring, and other accessories.



1 to 3 Pairs — Connector Fitted

Air and Vacuum-side Connectors Included

CONFLAT FLANGE

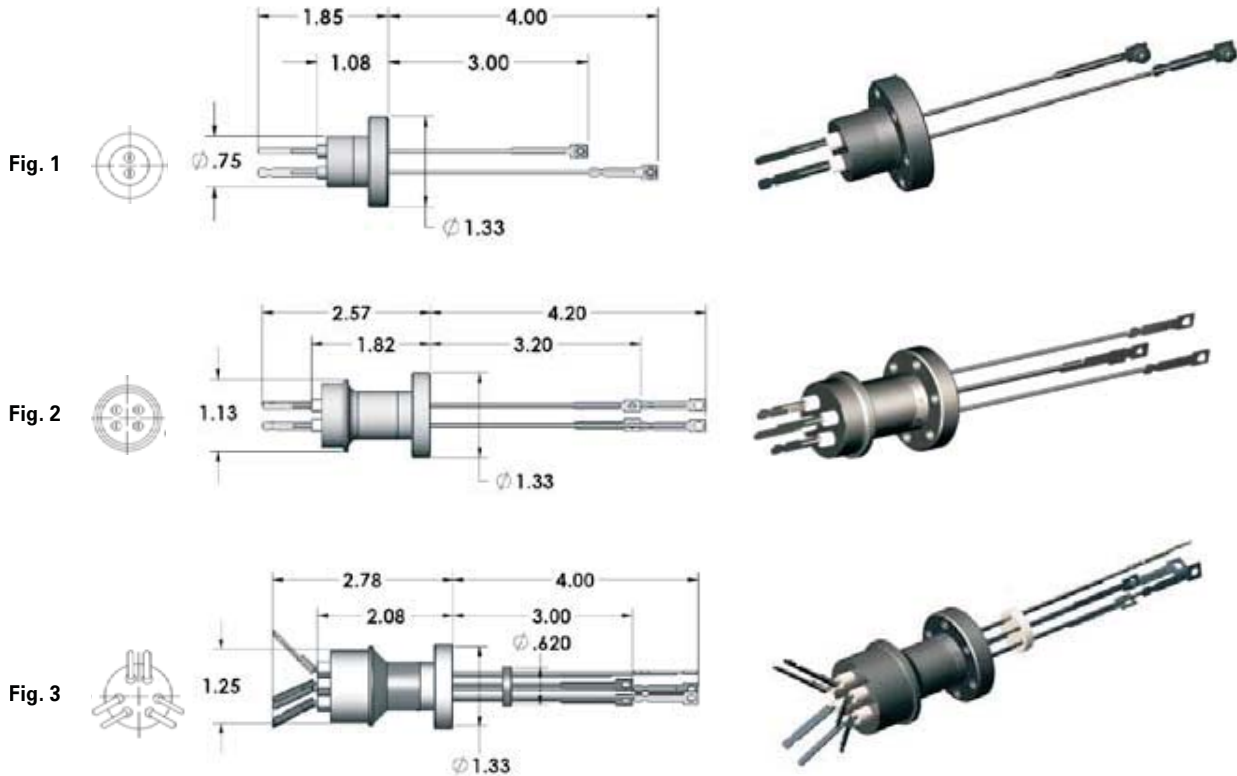

# PAIRS	TYPE	FIG	PART #		PRICE
			CF16 / 1.33	CF40 / 2.75	
				(NOT SHOWN)	
1	C	1	A0391-3-CF	A2288-3-CF	105.00 / 120.00
1	E	1	A0391-4-CF	A2288-4-CF	105.00 / 120.00
1	J	1	A0391-1-CF	A2288-1-CF	105.00 / 120.00
1	K	1	A0391-2-CF	A2288-2-CF	105.00 / 120.00
2	C	2	A0407-3-CF	A2612-3-CF	160.00 / 175.00
2	E	2	A0407-4-CF	A2612-4-CF	160.00 / 175.00
2	J	2	A0407-1-CF	A2612-1-CF	160.00 / 175.00
2	K	2	A0407-2-CF	A2612-2-CF	160.00 / 175.00
3	C	3	A0734-4-CF	A5775-3-CF	240.00 / 255.00
3	E	3	A0734-3-CF	A5775-4-CF	240.00 / 255.00
3	J	3	A0734-2-CF	A5775-1-CF	240.00 / 255.00
3	K	3	A0734-1-CF	A5775-2-CF	240.00 / 255.00

See Section 7 for connectors, wiring, and other accessories.



1 to 3 Pairs — Connector Fitted

Air and Vacuum-side Connectors Included

QUICK FLANGE

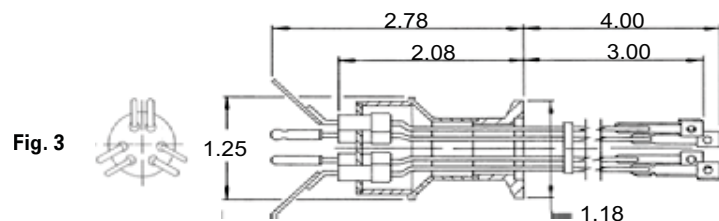
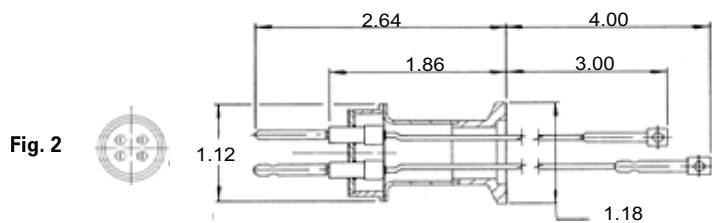
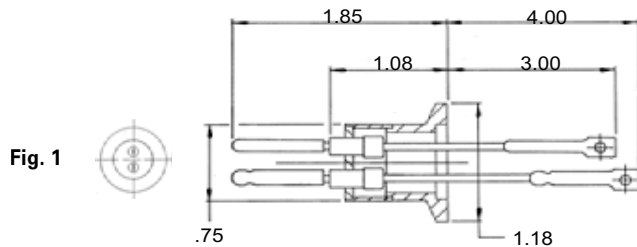

# PAIRS	TYPE	FIG	PART #	PRICE
1	C	1	A0392-3-QF	105.00
1	E	1	A0392-4-QF	105.00
1	J	1	A0392-1-QF	105.00
1	K	1	A0392-2-QF	105.00
2	C	2	A0408-3-QF	160.00
2	E	2	A0408-4-QF	160.00
2	J	2	A0408-1-QF	160.00
2	K	2	A0408-2-QF	160.00
3	C	3	A0782-4-QF	240.00
3	E	3	A0782-3-QF	240.00
3	J	3	A0782-2-QF	240.00
3	K	3	A0782-1-QF	240.00

See Section 7 for connectors, wiring, and other accessories.



1 to 3 Pairs — Connector Fitted

Air and Vacuum-side Connectors Included

NPT PIPE THREAD

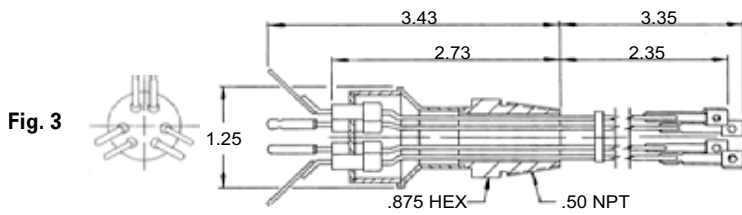
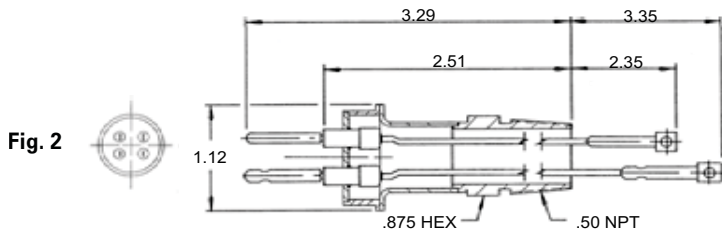
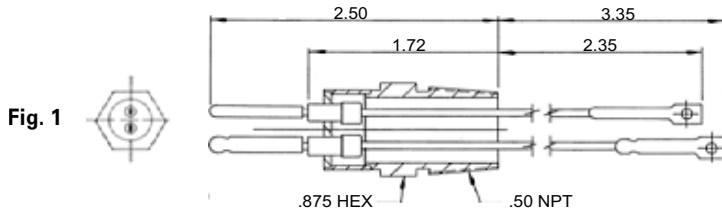

# PAIRS	TYPE	FIG	PART #	PRICE
1	C	1	A0393-3-NPT	117.00
1	E	1	A0393-4-NPT	117.00
1	J	1	A0393-1-NPT	117.00
1	K	1	A0393-2-NPT	117.00
2	C	2	A0409-3-NPT	189.00
2	E	2	A0409-4-NPT	189.00
2	J	2	A0409-1-NPT	189.00
2	K	2	A0409-2-NPT	189.00
3	C	3	A0786-1-NPT	296.00
3	E	3	A0786-2-NPT	296.00
3	J	3	A0786-3-NPT	296.00
3	K	3	A0786-4-NPT	296.00

See Section 7 for connectors, wiring, and other accessories.



1 to 2 Pairs — Connector Fitted
Air and Vacuum-side Connectors Included
1" BASEPLATE BOLT

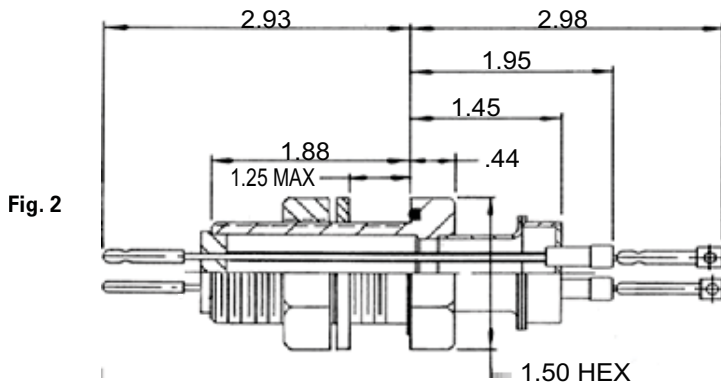
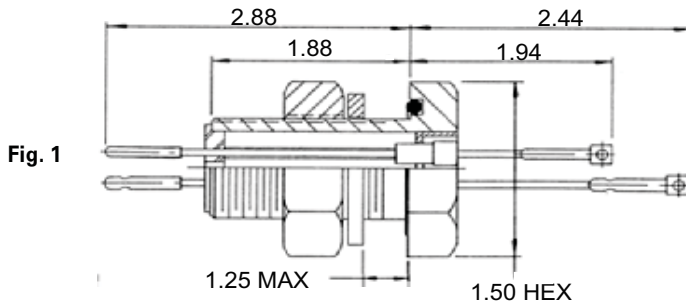

# PAIRS	TYPE	FIG	PART #	PRICE
1	C	1	A0418-3-BP	162.00
1	E	1	A0418-4-BP	162.00
1	J	1	A0418-1-BP	162.00
1	K	1	A0418-2-BP	162.00
2	C	2	A0785-3-BP	309.00
2	E	2	A0785-4-BP	309.00
2	J	2	A0785-1-BP	309.00
2	K	2	A0785-2-BP	309.00



4 to 5 Pairs — Connector Fitted

Air and Vacuum-side Connectors Included

WELDABLE

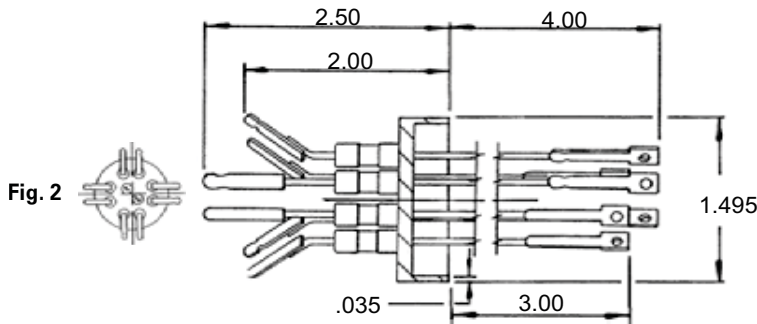
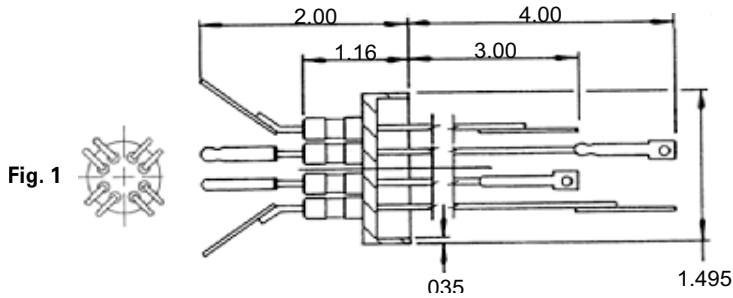

# PAIRS	TYPE	FIG	PART #	PRICE
4	C	1	A0720-4-W	318.00
4	E	1	A0720-3-W	318.00
4	J	1	A0720-2-W	318.00
4	K	1	A0720-1-W	318.00
5	C	2	A0656-3-W	395.00
5	E	2	A0656-4-W	395.00
5	J	2	A0656-2-W	395.00
5	K	2	A0656-1-W	395.00

See Section 7 for connectors, wiring, and other accessories.



4 to 5 Pairs — Connector Fitted

Air and Vacuum-side Connectors Included

CONFLAT FLANGE

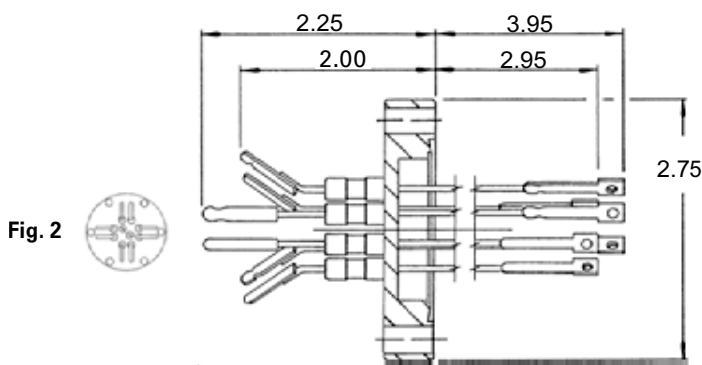
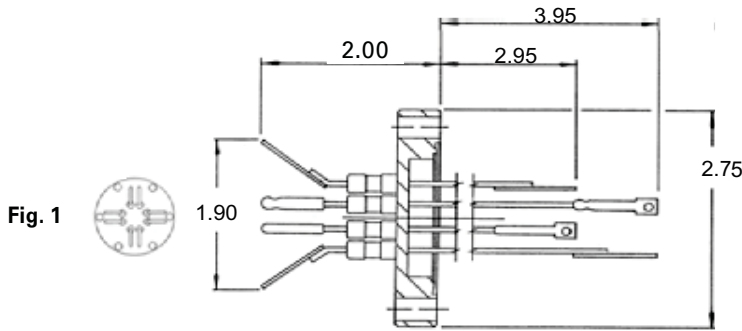

# PAIRS	TYPE	FIG	PART #	PRICE
4	C	1	A0462-3-CF	375.00
4	E	1	A0462-4-CF	375.00
4	J	1	A0462-2-CF	375.00
4	K	1	A0462-1-CF	375.00
5	C	2	A0459-3-CF	440.00
5	E	2	A0459-4-CF	440.00
5	J	2	A0459-2-CF	440.00
5	K	2	A0459-1-CF	440.00



4 to 5 Pairs — Connector Fitted

Air and Vacuum-side Connectors Included

QUICK FLANGE

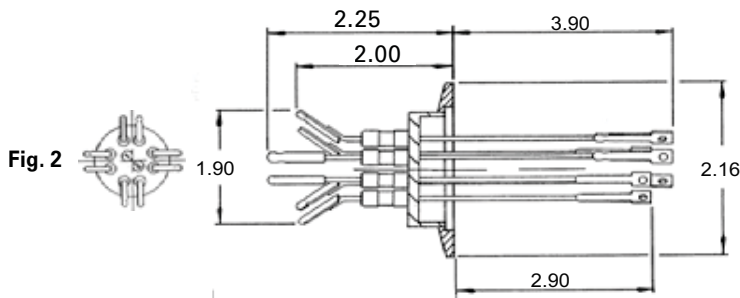
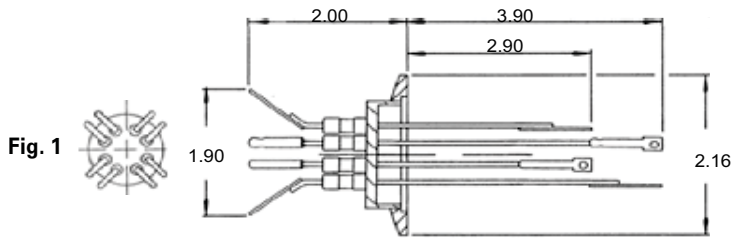

# PAIRS	TYPE	FIG	PART #	PRICE
4	C	1	A0784-1-QF	375.00
4	E	1	A0784-2-QF	375.00
4	J	1	A0784-3-QF	375.00
4	K	1	A0784-4-QF	375.00
5	C	2	A0783-3-QF	440.00
5	E	2	A0783-4-QF	440.00
5	J	2	A0783-2-QF	440.00
5	K	2	A0783-1-QF	440.00

See Section 7 for connectors, wiring, and other accessories.



1 to 3 Pairs — Screw-type Connection

Air and Vacuum-side Connectors Included

WELDABLE

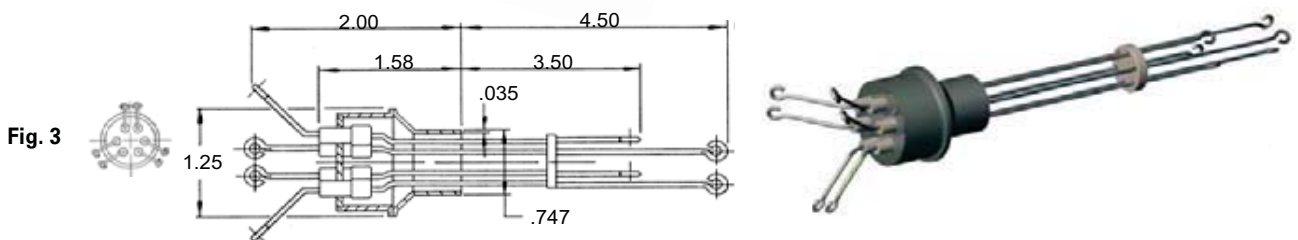
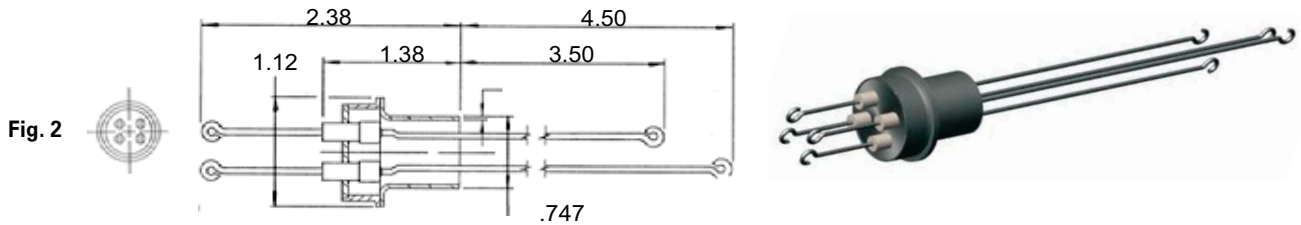
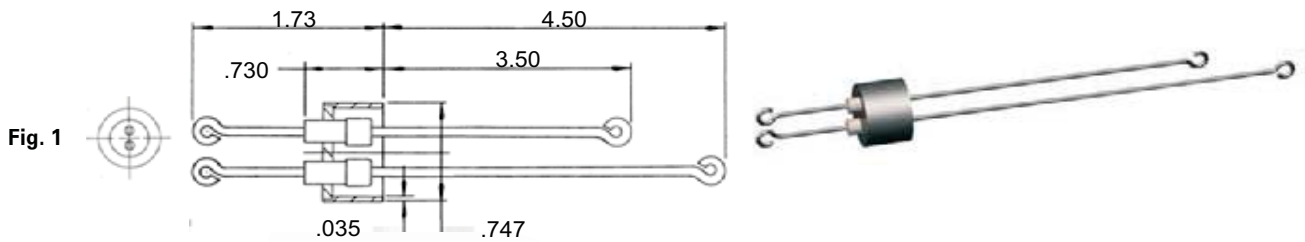

# PAIRS	TYPE	FIG	PART #	PRICE
1	R, S	1	A0396-1-W	87.00
1	N	1	A0397-3-W	87.00
1	T	1	A0397-1-W	87.00
2	R, S	2	A0411-2-W	149.00
2	N	2	A0411-3-W	149.00
2	T	2	A0411-1-W	149.00
3	R, S	3	A0787-2-W	266.00
3	N	3	A0787-3-W	266.00
3	T	3	A0787-1-W	266.00



1 to 3 Pairs — Screw-type Connection

Air and Vacuum-side Connectors Included

CONFLAT FLANGE

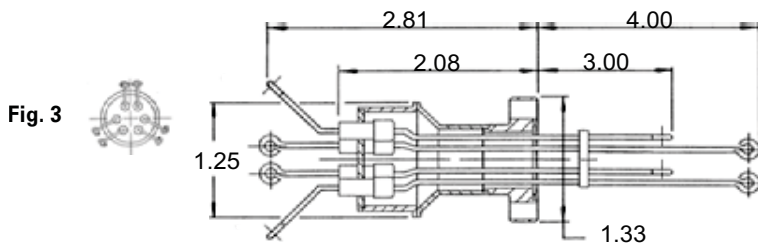
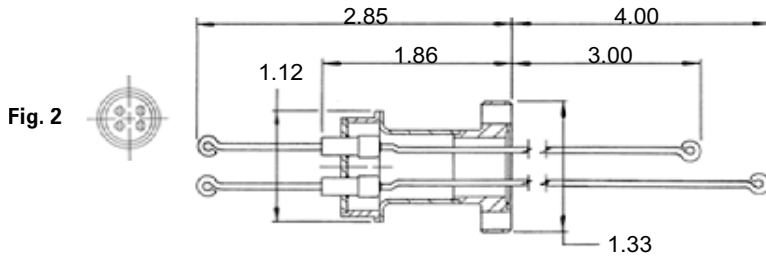
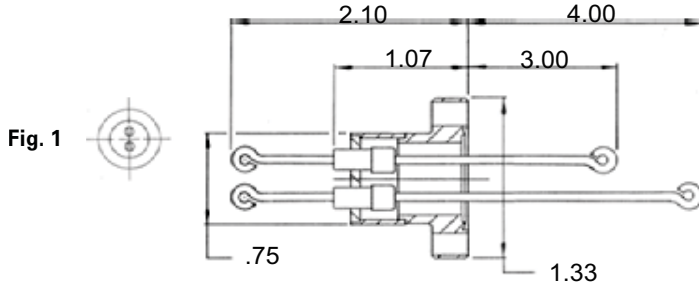

# PAIRS	TYPE	FIG	PART #	PRICE
1	R, S	1	A0399-2-CF	110.00
1	N	1	A0399-4-CF	110.00
1	T	1	A0399-1-CF	110.00
2	R, S	2	A0412-2-CF	170.00
2	N	2	A0412-3-CF	170.00
2	T	2	A0412-1-CF	170.00
3	R, S	3	A0791-2-CF	296.00
3	N	3	A0791-3-CF	296.00
3	T	3	A0791-1-CF	296.00

See Section 7 for connectors, wiring, and other accessories.



1 to 3 Pairs — Screw-type Connection

Air and Vacuum-side Connectors Included

QUICK FLANGE

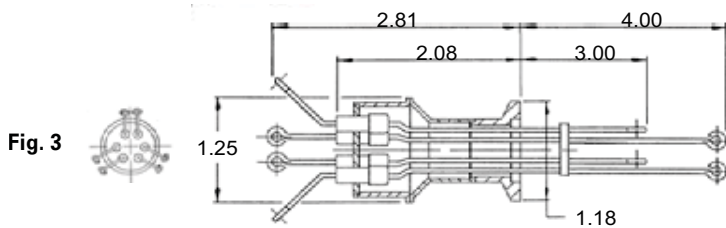
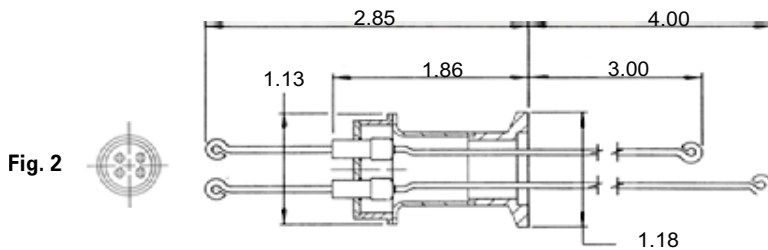
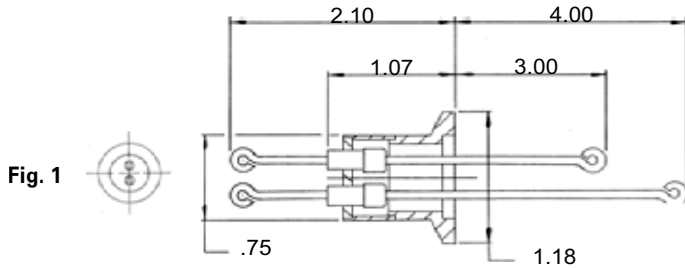

# PAIRS	TYPE	FIG	PART #	PRICE
1	R, S	1	A0400-2-QF	110.00
1	N	1	A0400-3-QF	110.00
1	T	1	A0400-1-QF	110.00
2	R, S	2	A0413-2-QF	170.00
2	N	2	A0413-3-QF	170.00
2	T	2	A0413-1-QF	170.00
3	R, S	3	A0792-2-QF	296.00
3	N	3	A0792-3-QF	296.00
3	T	3	A0792-1-QF	296.00

See Section 7 for connectors, wiring, and other accessories.



1 to 3 Pairs — Screw-type Connection

Air and Vacuum-side Connectors Included

NPT PIPE THREAD

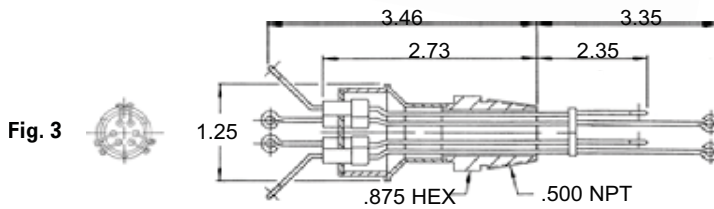
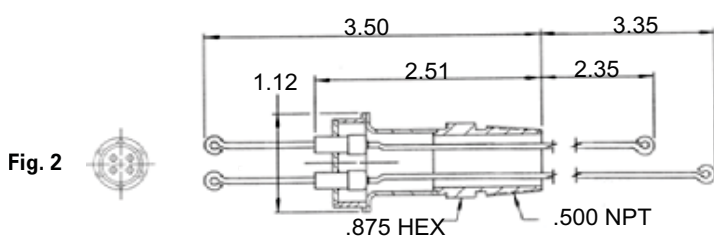
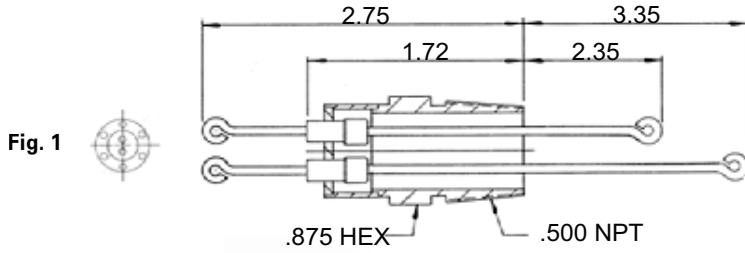

# PAIRS	TYPE	FIG	PART #	PRICE
1	R, S	1	A0401-2-NPT	127.00
1	N	1	A0401-3-NPT	127.00
1	T	1	A0401-1-NPT	127.00
2	R, S	2	A0414-2-NPT	199.00
2	N	2	A0414-3-NPT	199.00
2	T	2	A0414-1-NPT	199.00
3	R, S	3	A0793-2-NPT	321.00
3	N	3	A0793-3-NPT	321.00
3	T	3	A0793-1-NPT	321.00

See Section 7 for connectors, wiring, and other accessories.



1 to 2 Pairs — Screw-type Connection

Air and Vacuum-side Connectors Included

1" BASEPLATE

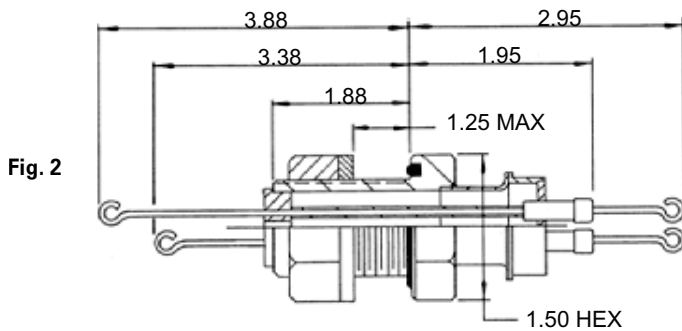
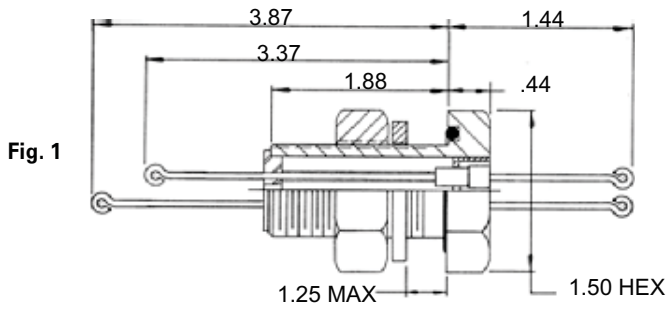

# PAIRS	TYPE	FIG	PART #	PRICE
1	R, S	1	A0419-2-BP	172.00
1	N	1	A0419-3-BP	172.00
1	T	1	A0419-1-BP	172.00
2	R, S	2	A0446-2-BP	319.00
2	N	2	A0446-3-BP	319.00
2	T	2	A0446-1-BP	319.00



4 to 5 Pairs — Screw-type Connection

Air and Vacuum-side Connectors Included

WELDABLE

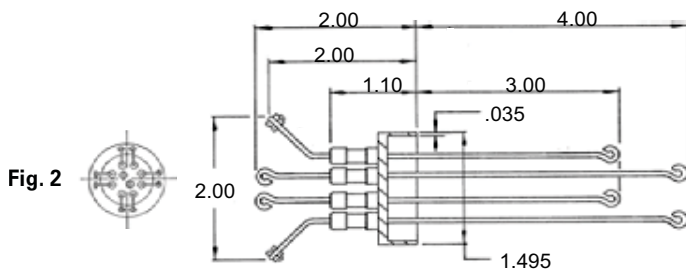
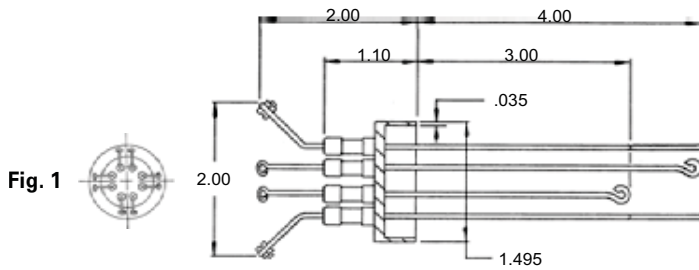

# PAIRS	TYPE	FIG	PART #	PRICE
4	R, S	1	A0788-2-W	373.00
4	N	1	A0788-3-W	373.00
4	T	1	A0788-1-W	373.00
5	R, S	2	A0789-2-W	485.00
5	N	2	A0789-3-W	485.00
5	T	2	A0789-1-W	485.00

See Section 7 for connectors, wiring, and other accessories.



4 to 5 Pairs — Screw-type Connection

Air and Vacuum-side Connectors Included

CONFLAT FLANGE

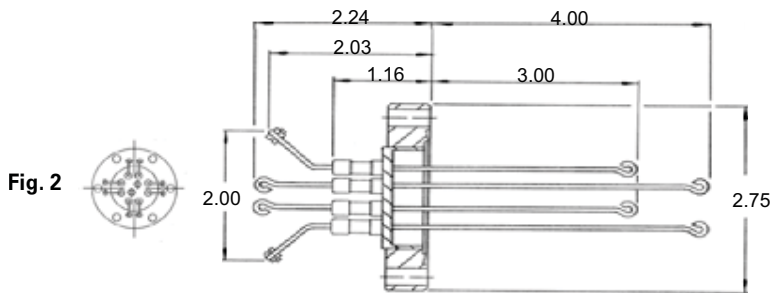
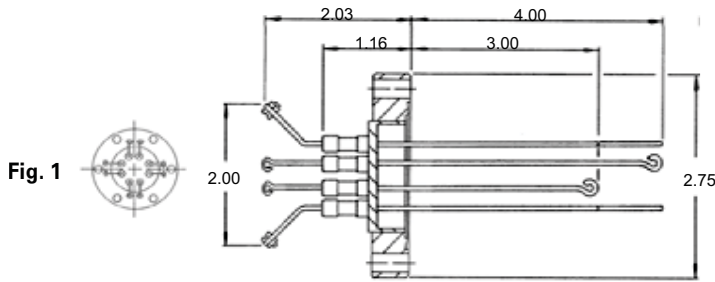

# PAIRS	TYPE	FIG	PART #	PRICE
4	R, S	1	A0795-2-CF	478.00
4	N	1	A0795-3-CF	478.00
4	T	1	A0795-1-CF	478.00
5	R, S	2	A0797-2-CF	590.00
5	N	2	A0797-3-CF	590.00
5	T	2	A0797-1-CF	590.00



4 to 5 Pairs — Screw-type Connection

Air and Vacuum-side Connectors Included

QUICK FLANGE

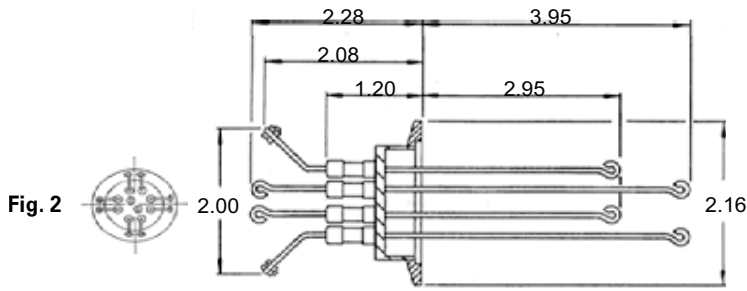
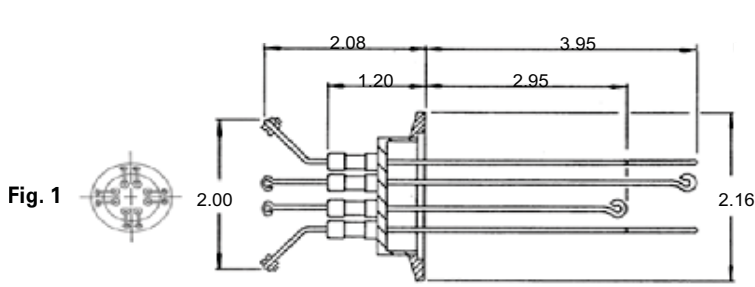

# PAIRS	TYPE	FIG	PART #	PRICE
4	R, S	1	A0796-2-QF	478.00
4	N	1	A0796-3-QF	478.00
4	T	1	A0796-1-QF	478.00
5	R, S	2	A0794-2-QF	590.00
5	N	2	A0794-3-QF	590.00
5	T	2	A0794-1-QF	590.00

See Section 7 for connectors, wiring, and other accessories.



2 to 10 Pairs — MS Connectors Single-ended

Air-side Connector Included

WELDABLE

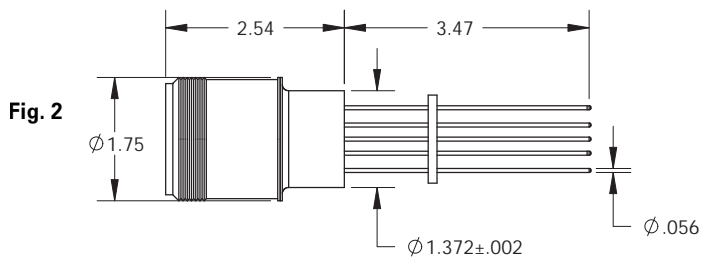
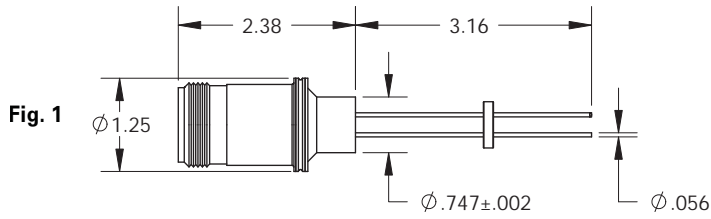

# PAIRS	TYPE	FIG	PART #	PRICE
2	E	1	A0429-3-W	235.00
2	J	1	A0429-2-W	235.00
2	K	1	A0429-1-W	235.00
3	E	1	A0429-7-W	260.00
3	J	1	A0429-6-W	260.00
3	K	1	A0429-5-W	260.00
5	E	1	A0429-11-W	330.00
5	J	1	A0429-10-W	330.00
5	K	1	A0429-9-W	330.00
10	E	2	A0204-3-W	600.00
10	J	2	A0204-2-W	600.00
10	K	2	A0204-1-W	600.00



2 to 10 Pairs — MS Connectors Single-ended

Air side connectors included

CONFLAT FLANGE

Fig. 1

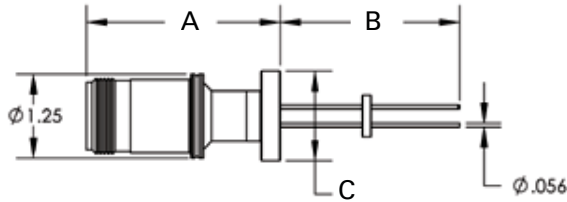
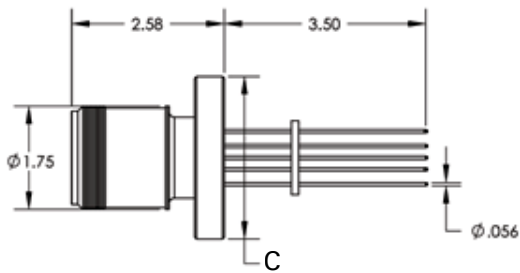

Fig. 2



# PAIRS	TYPE	FIG	A	B	C	PART #	PRICE
2	E	1	2.80	2.70	1.33	A0192-3-CF	280.00
2	J	1	2.80	2.70	1.33	A0192-2-CF	280.00
2	K	1	2.80	2.70	1.33	A0192-1-CF	280.00
2	E	1	2.30	3.20	2.75	A0193-3-CF	295.00
2	J	1	2.30	3.20	2.75	A0193-2-CF	295.00
2	K	1	2.30	3.20	2.75	A0193-1-CF	295.00
3	E	1	2.80	2.70	1.33	A0192-7-CF	310.00
3	J	1	2.80	2.70	1.33	A0192-6-CF	310.00
3	K	1	2.80	2.70	1.33	A0192-5-CF	310.00
3	E	1	2.30	3.20	2.75	A0193-7-CF	315.00
3	J	1	2.30	3.20	2.75	A0193-6-CF	315.00
3	K	1	2.30	3.20	2.75	A0193-5-CF	315.00
5	E	1	2.80	2.70	1.33	A0192-11-CF	370.00
5	J	1	2.80	2.70	1.33	A0192-10-CF	370.00
5	K	1	2.80	2.70	1.33	A0192-9-CF	370.00
5	E	1	2.30	3.20	2.75	A0193-11-CF	390.00
5	J	1	2.30	3.20	2.75	A0193-10-CF	390.00
5	K	1	2.30	3.20	2.75	A0193-9-CF	390.00
10	E	2	---	---	2.75	A0206-3-CF	695.00
10	J	2	---	---	2.75	A0206-2-CF	695.00
10	K	2	---	---	2.75	A0206-1-CF	695.00

See Section 7 for connectors, wiring, and other accessories.



2 to 10 Pairs — MS Connectors Single-ended

Air side connectors included

QUICK FLANGE

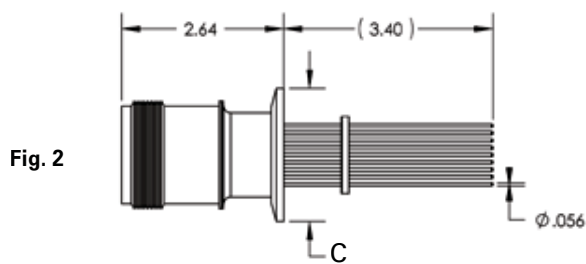
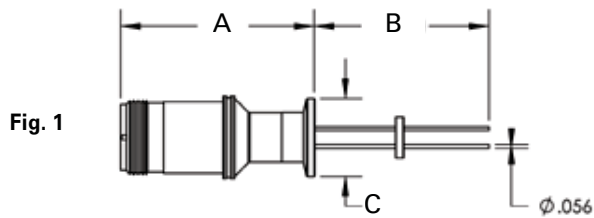

# PAIRS	TYPE	FIG	A	B	C	PART #	PRICE
2	E	1	2.80	2.70	1.18	A0197-3-QF	275.00
2	J	1	2.80	2.70	1.18	A0197-2-QF	275.00
2	K	1	2.80	2.70	1.18	A0197-1-QF	275.00
2	E	1	2.30	3.20	2.16	A0194-3-QF	290.00
2	J	1	2.30	3.20	2.16	A0194-2-QF	290.00
2	K	1	2.30	3.20	2.16	A0194-1-QF	290.00
3	E	1	2.80	2.70	1.18	A0197-7-QF	295.00
3	J	1	2.80	2.70	1.18	A0197-6-QF	295.00
3	K	1	2.80	2.70	1.18	A0197-5-QF	295.00
3	E	1	2.30	3.20	2.16	A0194-7-QF	310.00
3	J	1	2.30	3.20	2.16	A0194-6-QF	310.00
3	K	1	2.30	3.20	2.16	A0194-5-QF	310.00
5	E	1	2.80	2.70	1.18	A0197-11-QF	360.00
5	J	1	2.80	2.70	1.18	A0197-10-QF	360.00
5	K	1	2.80	2.70	1.18	A0197-9-QF	360.00
5	E	1	2.30	3.20	2.16	A0194-11-QF	380.00
5	J	1	2.30	3.20	2.16	A0194-10-QF	380.00
5	K	1	2.30	3.20	2.16	A0194-9-QF	380.00
10	E	2	---	---	2.16	A0209-3-QF	675.00
10	J	2	---	---	2.16	A0209-2-QF	675.00
10	K	2	---	---	2.16	A0209-1-QF	675.00

See Section 7 for connectors, wiring, and other accessories.



2 to 10 Pairs — MS Connectors Double-ended

Air and Vacuum-side Connectors Included

WELDABLE

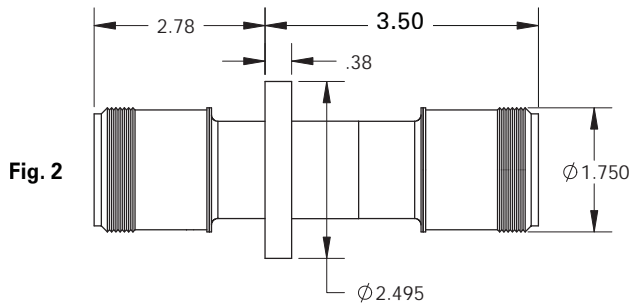
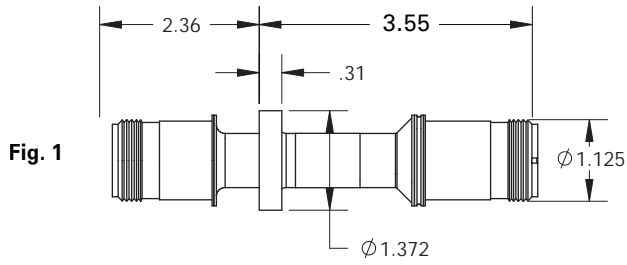

# PAIRS	TYPE	FIG	PART #	PRICE
2	E	1	A1149-1-W	940.00
2	J	1	A1092-1-W	940.00
2	K	1	A1074-1-W	940.00
3	E	1	A1093-1-W	1055.00
3	J	1	A1094-1-W	1055.00
3	K	1	A1095-1-W	1055.00
5	E	1	A1147-1-W	1245.00
5	J	1	A1096-1-W	1245.00
5	K	1	A1148-1-W	1245.00
10	E	2	A1097-1-W	1390.00
10	J	2	A1179-1-W	1390.00
10	K	2	A1180-1-W	1390.00

See Section 7 for connectors, wiring, and other accessories.



2 to 10 Pairs — MS Connectors Double-ended

Air and Vacuum-side Connectors Included

CONFLAT FLANGE

Fig. 1

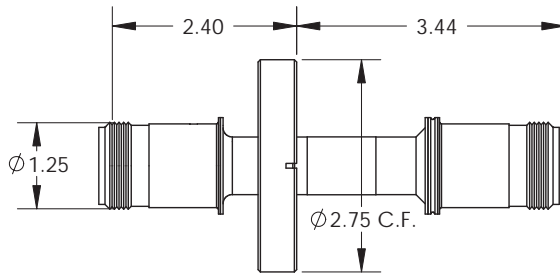
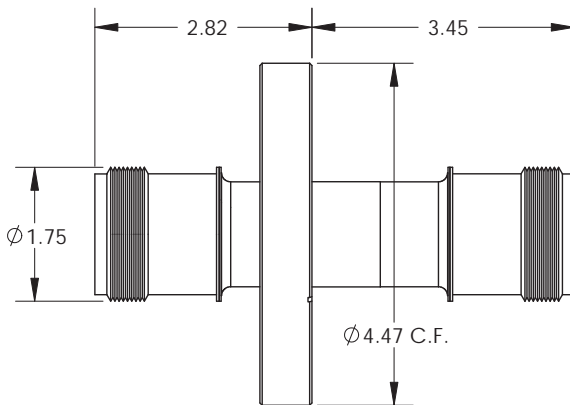

Fig. 2



# PAIRS	TYPE	FIG	PART #	PRICE
2	E	1	A1323-1-CF	995.00
2	J	1	A1323-2-CF	995.00
2	K	1	A1323-3-CF	995.00
3	E	1	A1324-1-CF	1110.00
3	J	1	A1324-2-CF	1110.00
3	K	1	A1324-3-CF	1110.00
5	E	1	A1320-1-CF	1365.00
5	J	1	A1320-2-CF	1365.00
5	K	1	A1320-3-CF	1365.00
10	E	2	A1325-1-CF	1565.00
10	J	2	A1325-2-CF	1565.00
10	K	2	A1325-3-CF	1565.00

See Section 7 for connectors, wiring, and other accessories.



2 to 5 Pairs — Push-on Connectors WELDABLE

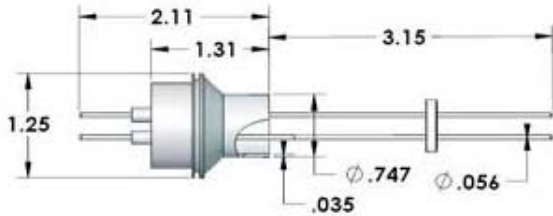

# PAIRS	TYPE	PART #	PRICE
2	E	A0421-3-W	140.00
2	J	A0421-2-W	140.00
2	K	A0421-1-W	140.00
3	E	A0422-3-W	155.00
3	J	A0422-2-W	155.00
3	K	A0422-1-W	155.00
5	E	A0184-3-W	225.00
5	J	A0184-2-W	225.00
5	K	A0184-1-W	225.00

2 to 5 Pairs — Push-on Connectors CONFLAT FLANGE

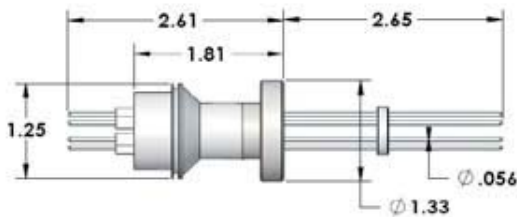

# PAIRS	TYPE	PART #	PRICE
2	E	A0423-3-CF	175.00
2	J	A0423-2-CF	175.00
2	K	A0423-1-CF	175.00
3	E	A0423-7-CF	190.00
3	J	A0423-6-CF	190.00
3	K	A0423-5-CF	190.00
5	E	A0423-11-CF	255.00
5	J	A0423-10-CF	255.00
5	K	A0423-9-CF	255.00

See Section 7 for connectors, wiring, and other accessories.



2 to 5 Pairs — Push-on Connectors
QUICK FLANGE

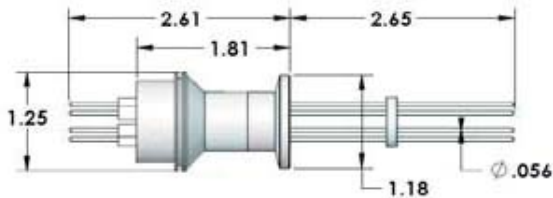

# PAIRS	TYPE	PART #	PRICE
2	E	A0425-3-QF	175.00
2	J	A0425-2-QF	175.00
2	K	A0425-1-QF	175.00
3	E	A0425-7-QF	190.00
3	J	A0425-6-QF	190.00
3	K	A0425-5-QF	190.00
5	E	A0425-11-QF	255.00
5	J	A0425-10-QF	255.00
5	K	A0425-9-QF	255.00

2 to 5 Pairs — Push-on Connectors
NPT PIPE THREAD

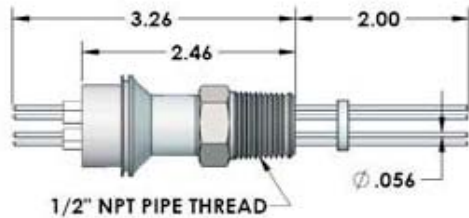

# PAIRS	TYPE	PART #	PRICE
2	E	A0424-3-NPT	200.00
2	J	A0424-2-NPT	200.00
2	K	A0424-1-NPT	200.00
3	E	A0424-7-NPT	215.00
3	J	A0424-6-NPT	215.00
3	K	A0424-5-NPT	215.00
5	E	A0424-11-NPT	285.00
5	J	A0424-10-NPT	285.00
5	K	A0424-9-NPT	285.00

See Section 7 for connectors, wiring, and other accessories.



1 T/C Pair & 1 Power Pair T/C Connectors

Air and vacuum side connectors for T/C included

WELDABLE

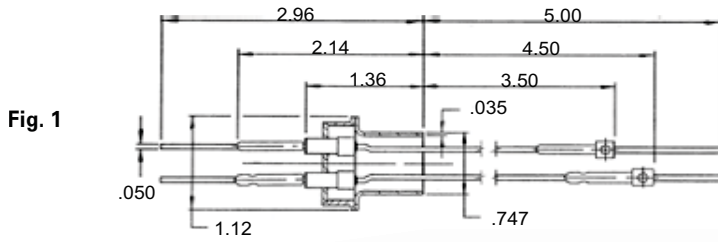

Fig. 1

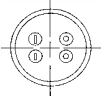
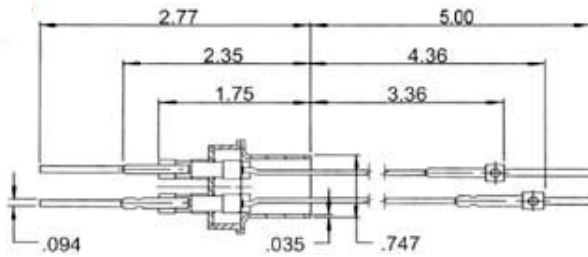

Fig. 2



AMPS	TYPE	VOLTAGE	FIG	CONDUCTOR	PART #	PRICE
15	C	1KV	1	COPPER	A0434-5-W	170.00
15	E	1KV	1	COPPER	A0434-7-W	170.00
15	J	1KV	1	COPPER	A0434-3-W	170.00
15	K	1KV	1	COPPER	A0434-1-W	170.00
5	C	1KV	1	NICKEL	A0434-6-W	170.00
5	E	1KV	1	NICKEL	A0434-8-W	170.00
5	J	1KV	1	NICKEL	A0434-4-W	170.00
5	K	1KV	1	NICKEL	A0434-2-W	170.00
30	C	5KV	2	COPPER	A0442-5-W	195.00
30	E	5KV	2	COPPER	A0442-7-W	195.00
30	J	5KV	2	COPPER	A0442-3-W	195.00
30	K	5KV	2	COPPER	A0442-1-W	195.00
15	C	5KV	2	NICKEL	A0442-6-W	195.00
15	E	5KV	2	NICKEL	A0442-8-W	195.00
15	J	5KV	2	NICKEL	A0442-4-W	195.00
15	K	5KV	2	NICKEL	A0442-2-W	195.00

See Section 7 for connectors, wiring, and other accessories.



1 T/C Pair & 1 Power Pair T/C Connectors

Air and vacuum side connectors for T/C included

CONFLAT FLANGE

Fig. 1

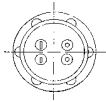
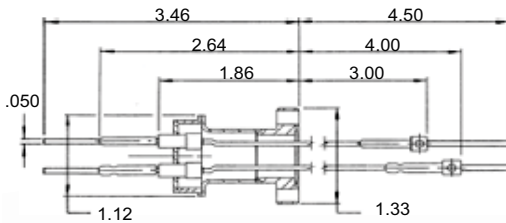
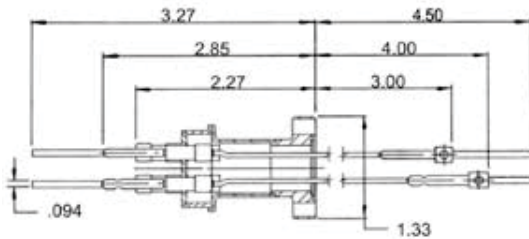

Fig. 2



AMPS	TYPE	VOLTAGE	FIG	CONDUCTOR	PART #		PRICE
					CF16 / 1.33	CF40 / 2.75	
<i>(NOT SHOWN)</i>							
5	C	1KV	1	NICKEL	A0436-6-CF	A2267-6-CF	200.00 / 215.00
5	E	1KV	1	NICKEL	A0436-8-CF	A2267-8-CF	200.00 / 215.00
5	J	1KV	1	NICKEL	A0436-4-CF	A2267-4-CF	200.00 / 215.00
5	K	1KV	1	NICKEL	A0436-2-CF	A2267-2-CF	200.00 / 215.00
15	C	1KV	1	COPPER	A0436-5-CF	A2267-5-CF	205.00 / 220.00
15	E	1KV	1	COPPER	A0436-7-CF	A2267-7-CF	205.00 / 220.00
15	J	1KV	1	COPPER	A0436-3-CF	A2267-3-CF	205.00 / 220.00
15	K	1KV	1	COPPER	A0436-1-CF	A2267-1-CF	205.00 / 220.00
15	C	5KV	2	NICKEL	A0443-6-CF	A2277-6-CF	225.00 / 255.00
15	E	5KV	2	NICKEL	A0443-8-CF	A2277-8-CF	225.00 / 255.00
15	J	5KV	2	NICKEL	A0443-4-CF	A2277-4-CF	225.00 / 255.00
15	K	5KV	2	NICKEL	A0443-2-CF	A2277-2-CF	225.00 / 255.00
30	C	5KV	2	COPPER	A0443-5-CF	A2277-5-CF	230.00 / 265.00
30	E	5KV	2	COPPER	A0443-7-CF	A2277-7-CF	230.00 / 265.00
30	J	5KV	2	COPPER	A0443-3-CF	A2277-3-CF	230.00 / 265.00
30	K	5KV	2	COPPER	A0443-1-CF	A2277-1-CF	230.00 / 265.00

See Section 7 for connectors, wiring, and other accessories.



1 T/C Pair & 1 Power Pair T/C Connectors

Air and vacuum side connectors for T/C included

QUICK FLANGE

Fig. 1

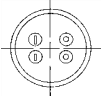
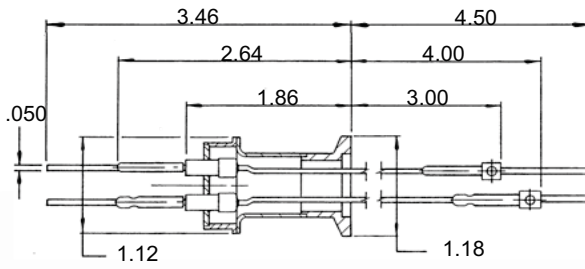
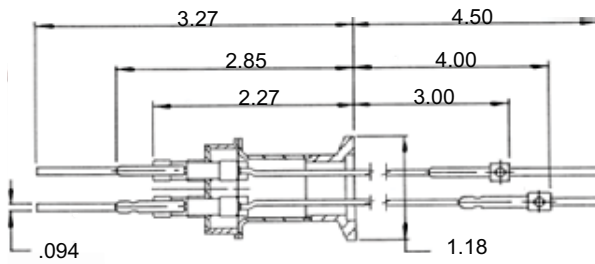

Fig. 2



AMPS	TYPE	VOLTAGE	FIG	CONDUCTOR	PART #	PRICE
5	C	1KV	1	NICKEL	A0435-6-QF	205.00
5	E	1KV	1	NICKEL	A0435-8-QF	205.00
5	J	1KV	1	NICKEL	A0435-4-QF	205.00
5	K	1KV	1	NICKEL	A0435-2-QF	205.00
15	C	1KV	1	COPPER	A0435-5-QF	210.00
15	E	1KV	1	COPPER	A0435-7-QF	210.00
15	J	1KV	1	COPPER	A0435-3-QF	210.00
15	K	1KV	1	COPPER	A0435-1-QF	210.00
15	C	5KV	2	NICKEL	A0444-6-QF	225.00
15	E	5KV	2	NICKEL	A0444-8-QF	225.00
15	J	5KV	2	NICKEL	A0444-4-QF	225.00
15	K	5KV	2	NICKEL	A0444-2-QF	225.00
30	C	5KV	2	COPPER	A0444-5-QF	230.00
30	E	5KV	2	COPPER	A0444-7-QF	230.00
30	J	5KV	2	COPPER	A0444-3-QF	230.00
30	K	5KV	2	COPPER	A0444-1-QF	230.00

See Section 7 for connectors, wiring, and other accessories.



1 & 2 T/C Pairs & 3 Power Pins T/C Connectors

Air and vacuum side connectors for T/C included

CONFLAT FLANGE

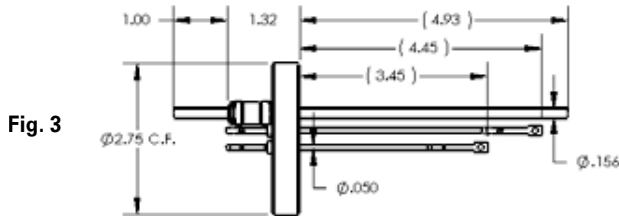
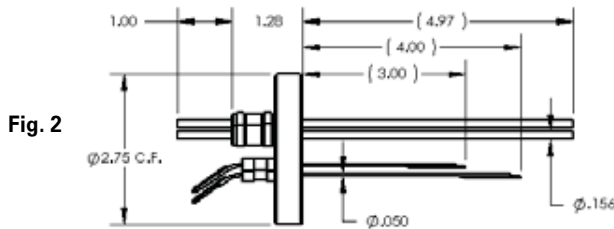
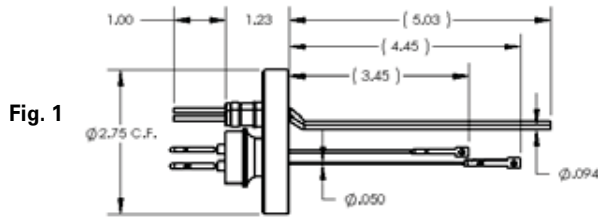

AMPS	TC PAIRS	TYPE	VOLTAGE	FIG	CONDUCTOR	PART #	PRICE
30	2	C	5KV	1	.094 COPPER	A0451-3-CF	425.00
30	2	E	5KV	1	.094 COPPER	A0451-4-CF	425.00
30	2	J	5KV	1	.094 COPPER	A0451-1-CF	425.00
30	2	K	5KV	1	.094 COPPER	A0451-2-CF	425.00
60	1	C	5KV	2	.156 COPPER	A0453-3-CF	405.00
60	1	E	5KV	2	.156 COPPER	A0453-4-CF	405.00
60	1	J	5KV	2	.156 COPPER	A0453-1-CF	405.00
60	1	K	5KV	2	.156 COPPER	A0453-2-CF	405.00
60	2	C	5KV	3	.156 COPPER	A0800-3-CF	445.00
60	2	E	5KV	3	.156 COPPER	A0800-4-CF	445.00
60	2	J	5KV	3	.156 COPPER	A0800-1-CF	445.00
60	2	K	5KV	3	.156 COPPER	A0800-2-CF	445.00

See Section 7 for connectors, wiring, and other accessories.



1 & 2 T/C Pairs & 1 Power Pair T/C Connectors

Air and vacuum side connectors for T/C included

CONFLAT FLANGE

Fig. 1

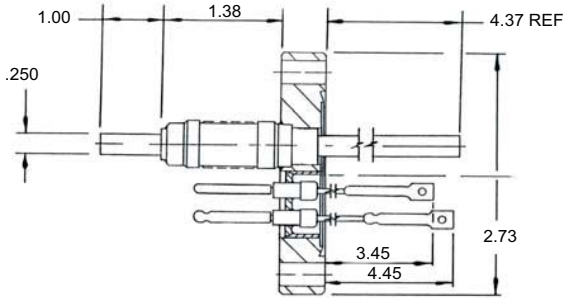
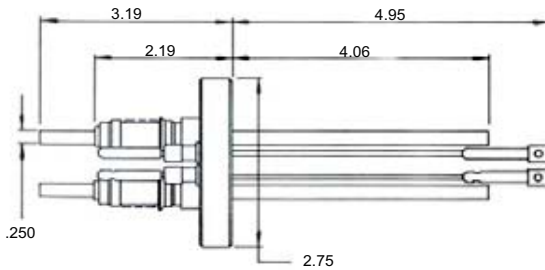

Fig. 2



AMPS	TC PAIRS	TYPE	VOLTAGE	FIG	CONDUCTOR	PART #	PRICE
150	1	C	5KV	1	.250 COPPER	A0458-3-CF	400.00
150	1	E	5KV	1	.250 COPPER	A0458-4-CF	400.00
150	1	J	5KV	1	.250 COPPER	A0458-1-CF	400.00
150	1	K	5KV	1	.250 COPPER	A0458-2-CF	400.00
150	2	C	5KV	2	.250 COPPER	A0798-2-CF	440.00
150	2	E	5KV	2	.250 COPPER	A0798-4-CF	440.00
150	2	J	5KV	2	.250 COPPER	A0798-3-CF	440.00
150	2	K	5KV	2	.250 COPPER	A0798-1-CF	440.00

See Section 7 for connectors, wiring, and other accessories.

